

SEM

Scanning Electron Microscope A To Z

Basic Knowledge For Using The SEM

JEOL

Serving Advanced Technology

Basic Knowledge For Using The SEM

Since the Scanning Electron Microscope (SEM) was first commercialized about 40 years ago, the SEM has shown a remarkable progress. Now, many types of SEMs are being used, and their performance and functions are greatly different from each other. To utilize these different SEMs, it is essential to recognize their features, as well as to understand the reasons for the contrast of SEM images. Thus, this document material is aimed at helping SEM users and future SEM users to understand the basics of the SEM, including the instrument principles, specimen preparation and elemental analysis.

Contents

Construction of SEM	3
Construction of Instrument	
Electron Gun	
Construction of Lens	
Condenser Lens and Objective Lens	
Specimen Stage	
Secondary Electron Detector	
Image Display and Recording	
Vacuum System	
Magnification of SEM	7
Depth of Focus of SEM	8
Why Images Are Visible?	9
Interactions of Electrons with Substances	
Secondary Electrons	
Backscattered Electrons	
Edge Effect	
Influence of Accelerating Voltage	
Illumination Effect of Secondary Electron Detector	
Illumination Effect of Backscattered Electron Detector	
To Improve Image Resolution	15
Resolution and Resolving Power	
To Improve Resolution	
Types of Electron Guns	16
Filed-Emission Electron Gun	
Schottky-Emission Electron Gun	
Features of Three Types of Electron Guns	
Types and Capabilities of Objective Lenses	18
Conventional Objective Lens	
Strongly Excited Objective Lens for High Resolution	
Role of Objective Lens Aperture	
Actual Resolution of SEM	20
Charging and Its Influence	21
What is Charging?	
Influence of Charging on SEM Image	
To Prevent Charging	
Basics of Specimen Preparation	24
Exposing Surface to Observe and Contrast Enhancement	
Mounting Specimen	
Coating	
Treatment of Biological Specimen	
Low Vacuum SEM	26
Basics of Elemental Analysis	27
Generation of X-rays	
X-ray Spectrometer	
Qualitative Analysis	
X-ray Mapping	
Analysis Area	
Quantitative Analysis	
Analysis of Non-conductive Specimen	
History	31

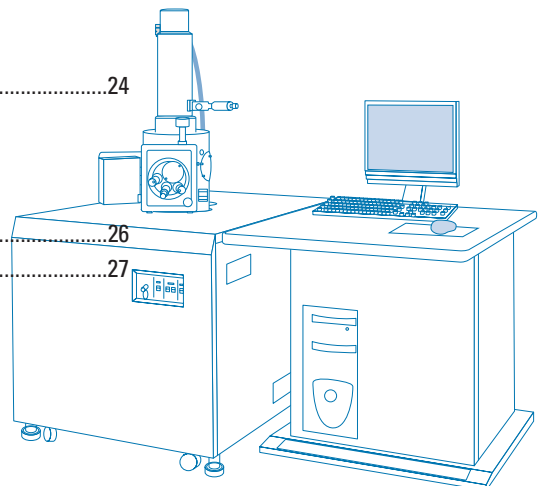
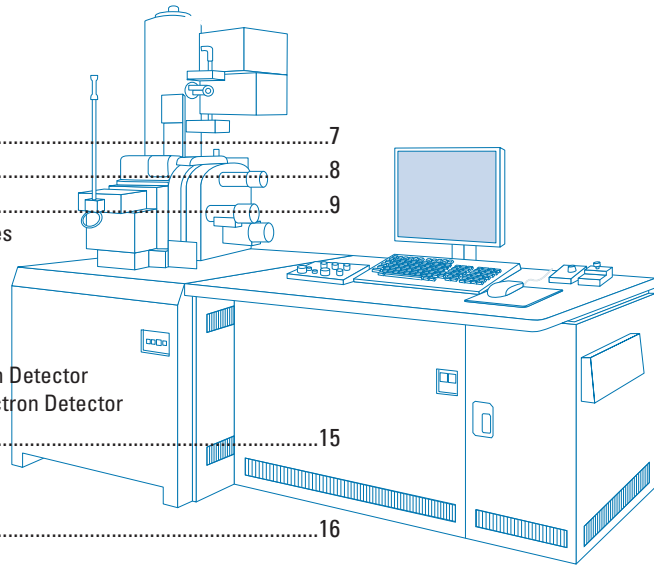

The Scanning Electron Microscope (SEM) is used for observation of specimen surfaces. When the specimen is irradiated with a fine electron probe, secondary electrons are emitted from the specimen surface. Topography of the surface can be observed by two-dimensional scanning of the electron probe over the surface and acquisition of an image from the detected secondary electrons.

Construction of SEM

Construction of Instrument

The SEM requires an electron optical system to produce an electron probe, a specimen stage to place the specimen, a secondary-electron detector to collect secondary electrons, an image display unit, and an operation system to perform various operations (Fig. 1). The electron optical system consists of an electron gun, a condenser lens and an objective lens to produce an electron probe, a scanning coil to scan the electron probe, and other components.

The electron optical system (inside of the microscope column) and a space surrounding the specimen are kept at vacuum.

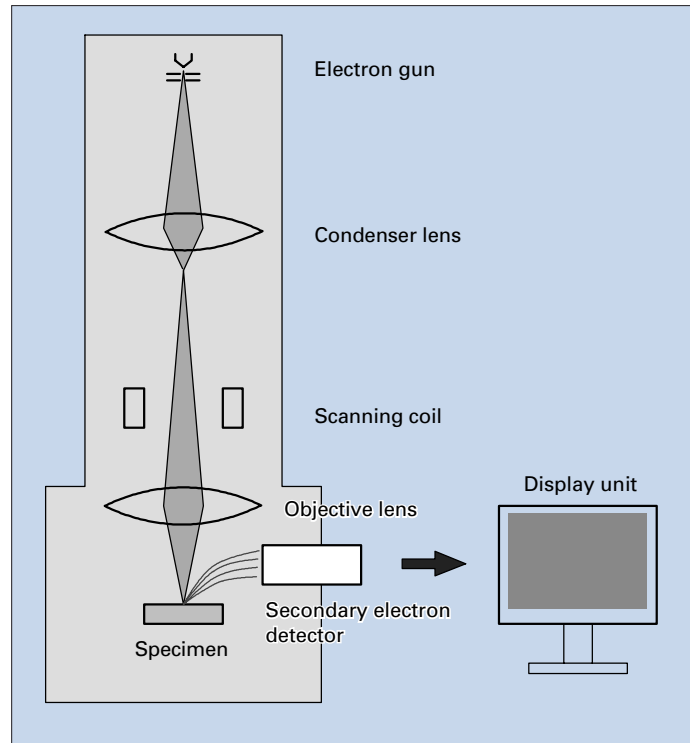

Fig. 1 Basic construction of a SEM.

Electron Gun

The electron gun produces an electron beam. Its construction is shown in Fig. 2. Note that this is a thermionic emission gun (TE gun). Thermo-electrons are emitted from a filament (cathode) made of a thin tungsten wire (about 0.1 mm) by heating the filament at high temperature (about 2800K). These thermo-electrons are gathered as an electron beam, flowing into the metal plate (anode) by applying a positive voltage (1 to 30 kV) to the anode. If a hole is made at the center of the anode, the electron beam flows through this hole. When you place an electrode (called a Wehnelt electrode) between the cathode and anode and apply a negative voltage to it, you can adjust the current of the electron beam. At this time, the electron beam is finely focused by the action of the Wehnelt electrode. The finest point of the beam is called the crossover, and this is regarded as an actual electron source with a diameter of 15 to 20 μm .

The TE gun, explained here, is most generally used. An LaB₆ single crystal is also used as a cathode, but it requires a higher vacuum because of its high activity. Other electron guns are the field-emission electron gun (FE gun) or the Schottky-emission electron gun (SE gun) (see page 16).

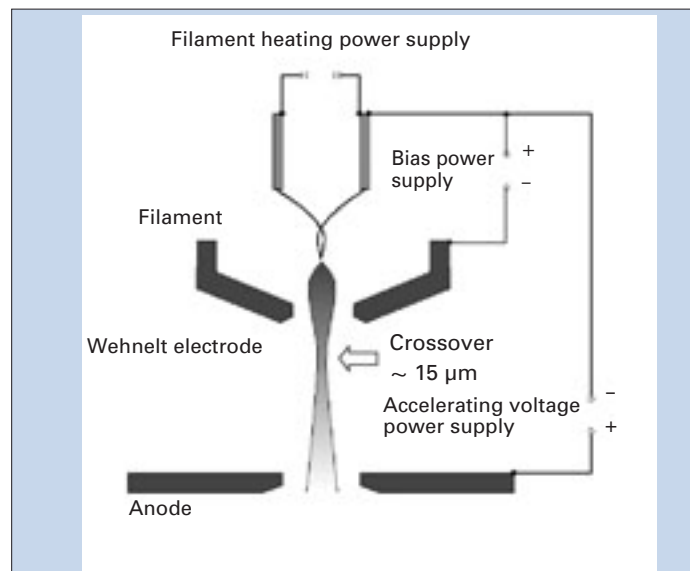

Fig. 2 Construction of an electron gun.

Construction of Lens

An electron microscope generally uses a magnetic lens. When you pass a direct electric current through a coil-wound electric wire, a rotationally-symmetric magnetic field is formed and a lens action is produced on an electron beam. To make a strong magnetic lens (with a short focal length), it is necessary to increase the density of the magnetic line. Thus, as shown in Fig. 3, the surroundings of the coil are enclosed by yokes so that part of the magnetic field leaks from a narrow gap. A portion with a narrow gap, called "polepiece," is fabricated with a high accuracy. The main feature of the magnetic lens is that when you change the current passing through the coil, the strength of the lens is also changed. This is not achieved by an optical lens.

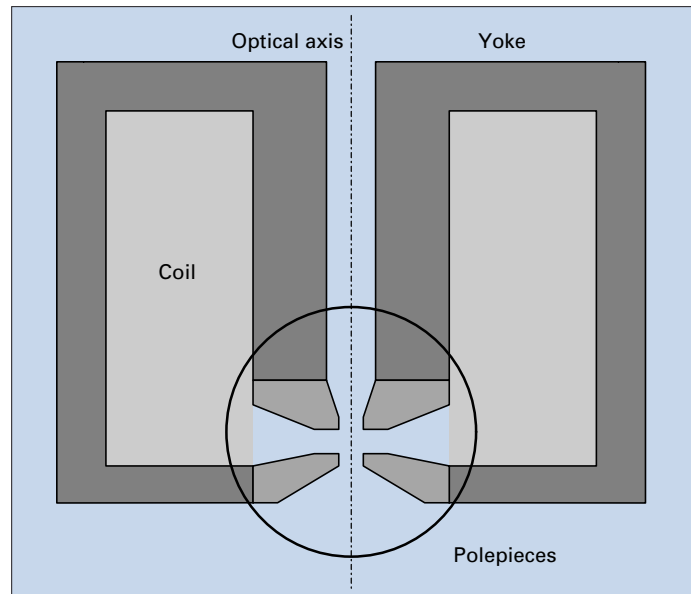

Fig. 3 Construction of a magnetic lens.

Condenser Lens and Objective Lens

Placing a lens below the electron gun enables you to adjust the diameter of the electron beam.

A fine electron beam (probe) is required for the SEM. Figure 4 illustrates the formation of a fine electron probe. Two-stage lenses, which combine the condenser and objective lenses, are located below the electron gun. The electron beam from the electron gun is focused by the two-stage lenses, and a small electron probe is produced.

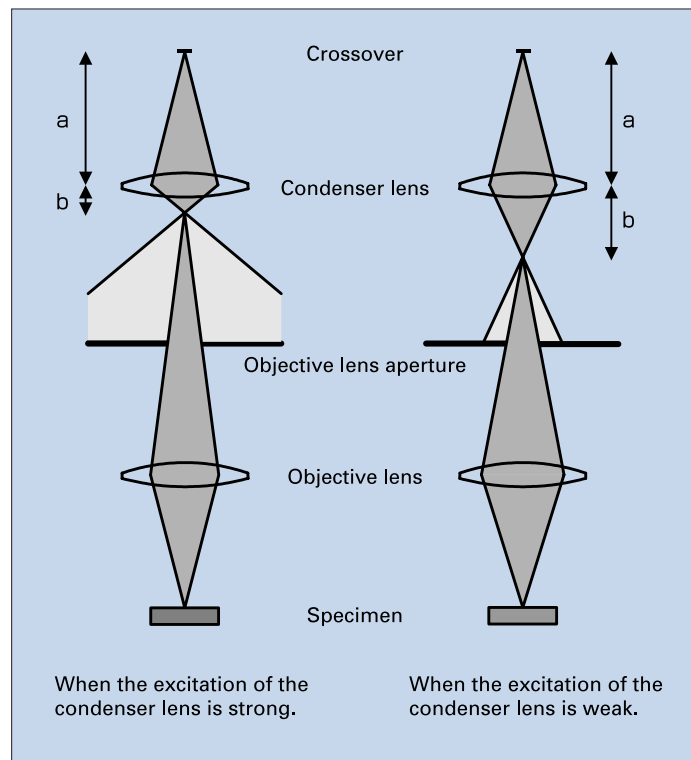

Fig. 4 Formation of the electron probe by the lenses.

●Role of the condenser lens

If the lens action of the condenser lens is strengthened, the electron probe becomes narrower with a smaller ratio of b/a , whereas if weakened, the electron probe becomes broader. The "aperture" is placed between the condenser lens and objective lens. The "aperture," made of a thin metal plate, has a small hole. The electron beam, which passed through the condenser lens, illuminates this aperture-plate. The aperture allows a part of the electron beam to reach the objective lens. If the excitation of the condenser lens is increased, the electron beam greatly broadens on the aperture and therefore, the number of the electrons (amount of probe current) reaching the objective lens is decreased. To the contrary, if the excitation of the condenser lens is decreased, the electron beam does not broaden very much and therefore, most of the electrons pass through the aperture and many electrons reach the objective lens. That is, the adjustment of the excitation of the condenser lens enables you to change the electron-probe diameter and the probe current.

However, even if the excitation of the condenser lens is infinitely increased, the diameter of the electron probe does not become infinitely small. This topic will be explained on page 15.

●Role of the objective lens

The objective lens is used for focusing, and this lens is a very important lens that determines the final diameter of the electron probe. If the performance of the objective lens is not good, an optimally-fine electron probe cannot be produced despite all of the efforts before the action of the objective lens. Thus, it is crucial to make the objective lens with the best performance.

Specimen Stage

In general, the specimen is observed at a high magnification in an electron microscope. Thus, a specimen stage, which stably supports the specimen and moves smoothly, is required. The specimen stage for a SEM can perform the following movements: horizontal movement (X, Y), vertical movement (Z), specimen tilting (T), and rotation (R). The X and Y movements are used for the selection of a field of view. While the Z movement provides the change of image resolution (see page 15) and the depth of focus (see page 8). Figure 5 shows the construction of the specimen stage.

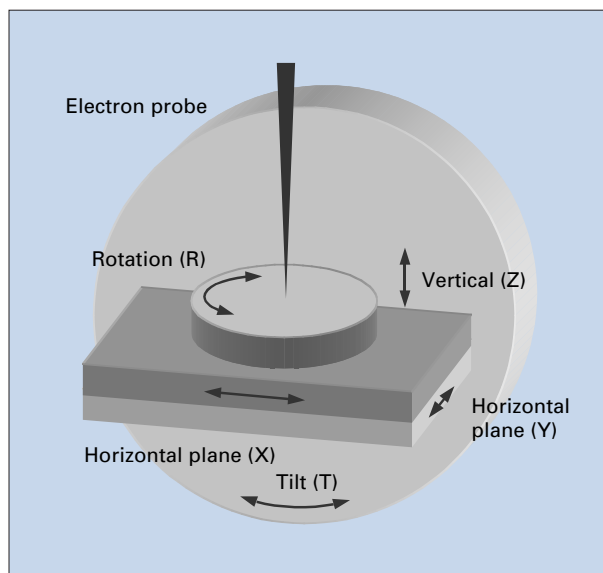

Fig. 5 Construction of the specimen stage.

Most SEMs use the eucentric specimen stage. By the use of this stage, the observation area does not shift while tilting the specimen and also, the focus on the specimen does not change after shifting the field of view while the specimen is tilted.

In addition to a conventional manual-drive stage, the use of motor-drive stages has increased in recent years. Furthermore, the use of a computer-controlled specimen stage has been increasing. With this stage, you can move the stage to a selected point by simply clicking a mouse, restore the stage to a desired observed point, and use more sophisticated eucentric capabilities.

Secondary Electron Detector

The secondary electron detector is used for detecting the secondary electrons emitted from the specimen. Its construction is shown in Fig. 6. A scintillator (fluorescent substance) is coated on the tip of the detector and a high voltage of about 10 kV is applied to it. The secondary electrons from the specimen are attracted to this high voltage and then generate light when they hit the scintillator. This light is directed to a photo-multiplier tube (PMT) through a light guide. Then, the light is converted to electrons, and these electrons are amplified as an electric signal. A supplementary electrode, called the collector, is placed before the scintillator. In general, in order to help the scintillator acquire secondary electrons, a few hundred volts is applied to this collector. By changing this voltage, you can control the number of secondary electrons to be collected. This type of the detector was originally developed by Everhart and Thornley, so this detector can be called the E-T detector. Many SEMs incorporate this detector in the specimen chamber; however, when a SEM is equipped with a strongly excited objective lens for higher resolution (see page 19), a secondary electron detector is placed above the objective lens and secondary electrons are detected by utilizing the lens magnetic fields. This detector is often called the TTL (Through The Lens) detector.

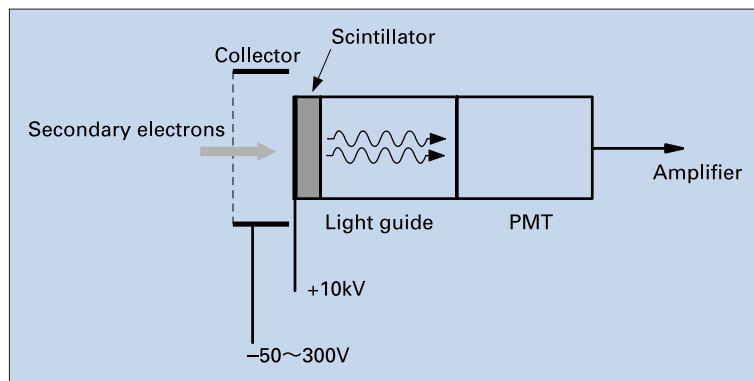

Fig. 6 Construction of the secondary electron detector.

Image Display and Recording

The output signals from the secondary electron detector are amplified and then transferred to the display unit. Since the scanning on the display unit is synchronized with the electron-probe scan, brightness variation, which depends on the number of the secondary electrons, appears on the monitor screen on the display unit, thus forming a SEM image. A cathode-ray tube (CRT) was used for many years as a display unit; however in recent years, a liquid-crystal display (LCD) has been widely used. In general, the scan speed of the electron probe can be changed in several steps, An extremely fast scan speed is used for observation and a slow scan speed is used for acquisition or saving of images.

To record an SEM image, in the past, the SEM image appearing on the CRT was photographed with a camera. But recently, the image has been recorded in a digital format (electronic file). This is because it is now difficult to get a high-resolution CRT and there are many advantages of electronic file. That is, it is easier to process images and convenient to send or receive image information. Note that an image format with 1M pixels is generally used for the electronic file.

Vacuum System

The inside of the electron optical system and the specimen chamber must be kept at a high vacuum of 10^{-3} to 10^{-4} Pa. Thus, these components are evacuated generally by a diffusion pump. If a user desires an oil-free environment, a turbo molecular pump may be used. When a SEM incorporates an FE gun (explained later), a sputter ion pump is used because the FE gun needs an ultrahigh vacuum.

To exchange a specimen, either of two methods is applied. One vents the entire specimen chamber at the time of specimen exchange. The other uses a specimen pre-evacuation chamber (airlock chamber) while keeping a high vacuum in the specimen chamber.

Magnification of SEM

When the specimen surface is two-dimensionally scanned by the electron probe, a SEM image appears on the monitor screen of the display unit. At this time, if the scan width of the electron probe is changed, the magnification of the displayed SEM image is also changed. Since the size of the monitor screen is unchanged, decreasing the scan width increases the magnification, whereas increasing the scan width decreases the magnification. Figure 7 shows this principle.

For example, when the size of the monitor screen is 10 cm and the scan width of the electron probe is 1 mm, the magnification is 100 times, whereas the scan width is 10 μm , 10,000 times. In terms of historical background, the magnification is expressed for a screen of 12 cm (horizontal) and 10 cm (vertical) as the standard (slightly different depending on a SEM manufacturer). If a display unit has a larger monitor screen compared to the standard size, the magnification of the displayed SEM image becomes larger. In such a case, the magnification and the size of an object is calculated with a scale bar displayed on the screen as a reference.

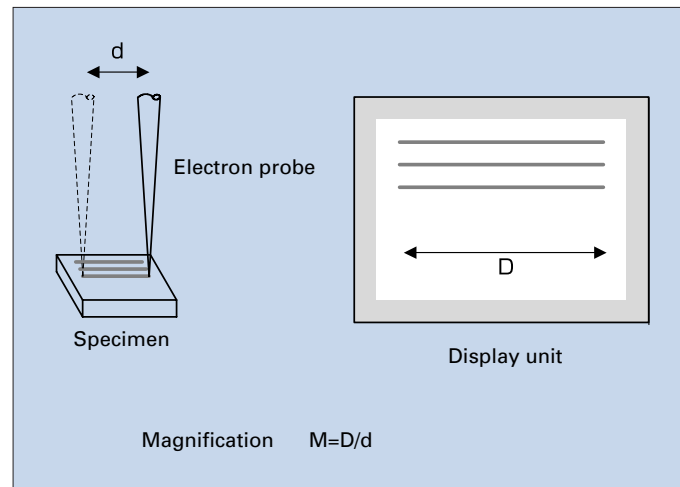

Fig. 7 Concept of SEM magnification.

Depth of Focus of SEM

In the observation of a specimen with a substantial depth, if the focus is adjusted to the top side, the bottom side may be out of focus. In such a case, if the range between upper and lower image blur is large, it is said that “the depth of focus is large.” Whereas if the range between upper and lower image blur is small, it is said that “the depth of focus is small.” As shown in Fig. 8, when the electron probe is considerably parallel (aperture angle is small), the image stays in focus even if the focus is changed by a large amount. Whereas when the electron probe is substantially angular (aperture angle is large), the image goes out of focus even if the focus is only slightly changed. In the case of an optical microscope (OM) where the probe scanning is not used for imaging, when the angle subtended by the objective lens from the specimen (aperture angle) is small, the depth of focus is large. Whereas when this angle is large, the depth of focus is small. Note that even when the image is blurred, this cannot be seen at a low magnification. However, when the magnification is increased, the image blur is found to appear. That is, the depth of focus is changed also by the magnification.

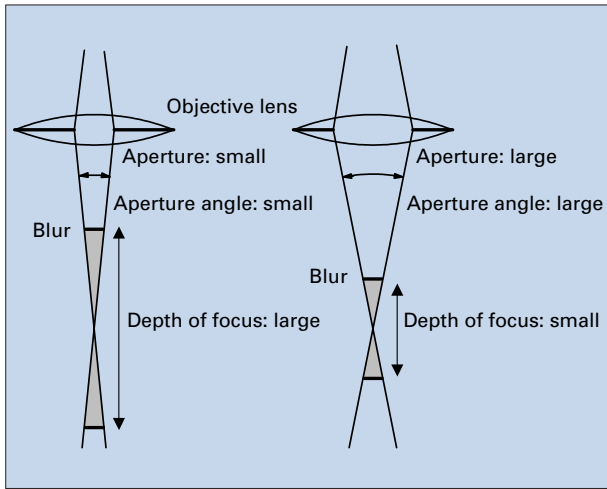

Fig. 8 Relation between the aperture angle of the electron probe and the depth of focus.

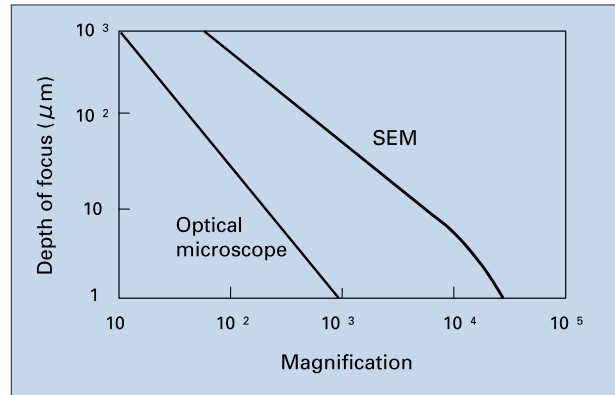

Fig. 9 Difference of the depth of focus between SEM and optical microscope.

Figure 9 is a graph that shows a difference of the depth of focus between the SEM and OM. Although a stereoscopic microscope provides an image with a relatively large depth of focus between OMs, you can obtain a much larger depth of focus with the SEM. This is because the aperture angle of the electron probe in the SEM is much smaller than that of the objective lens in the OM. Note that the depth of focus for the SEM is different depending on the observation conditions.

Figure 10 compares the OM and SEM images of a fractured surface of a screw. This fractured surface has large irregularity, leading to a fact that only a small part of the surface is actually focused with the OM. But, due to the large depth of focus of the SEM, the entire observed surface is in sharp focus.

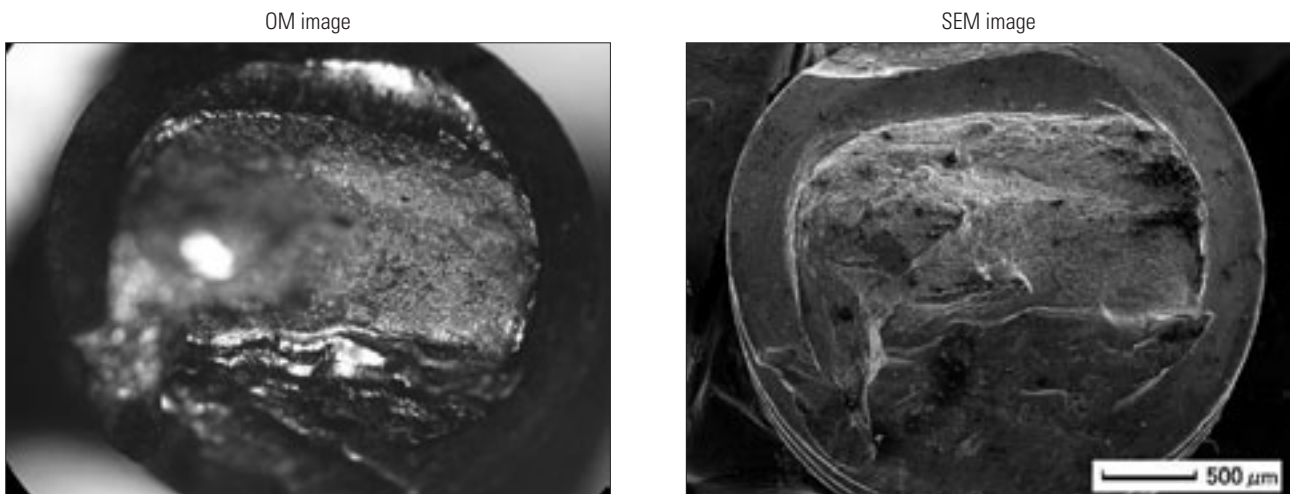

Fig. 10 OM image and SEM image of the same field of view.

Why Images Are Visible?

Since the SEM image appears as if you observe an object with the naked eye, you may intuitively understand the features of the object. However, the SEM image often produces a contrast that is difficult to explain. To fully understand the contrast of the SEM image, you must understand the principle of the formation of the SEM image.

Interactions of Electrons with Specimens

When electrons enter the specimen, the electrons are scattered within the specimen and gradually lose their energy, then they are absorbed in the specimen. This behavior is shown in Fig. 11. The scattering range of the electrons inside the specimen is different depending on the electron energy, the atomic number of the elements making up the specimen and the density of the constituent atoms. As the energy is higher, the scattering range is larger. To the contrary, if the atomic number and density are large, the scattering range is smaller. The Monte Carlo simulation enables us to understand these phenomena.

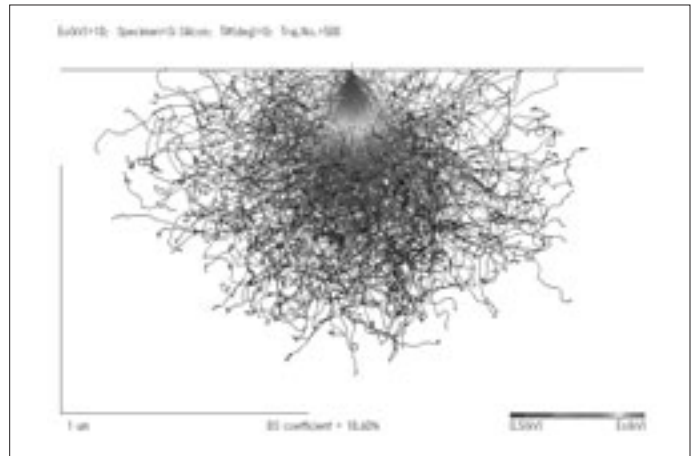

Fig. 11 Monte Carlo simulation showing the scattering behavior of electrons within the specimen.

Figure 12 is a schematic diagram that illustrates various signals emitted from the specimen when the incident electron beam enters the specimen. The SEM utilizes these signals to observe and analyze the specimen surface (or just beneath the surface). The SEM is not a simple morphology-observation instrument, but a versatile instrument capable of performing elemental analysis and state analysis.

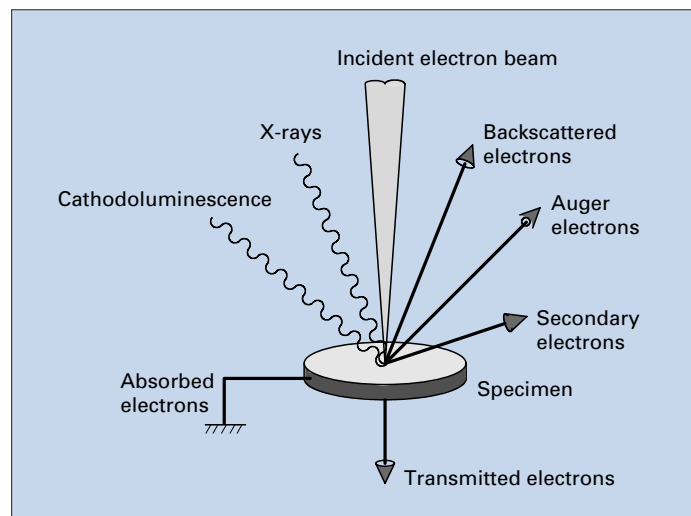

Fig. 12 Emission of various electrons and electromagnetic waves from the specimen.

Figure 13 shows the energy distribution of various electrons emitted from the specimen. The energy of secondary electrons is limited to 50 eV or less; however the energy distribution of backscattered electrons is very wide, ranging from an energy equal to the incident-electron energy down to 50 eV, which is far lower than the incident-electron energy. Small peaks that appear in the range of backscattered electrons correspond to Auger electrons.

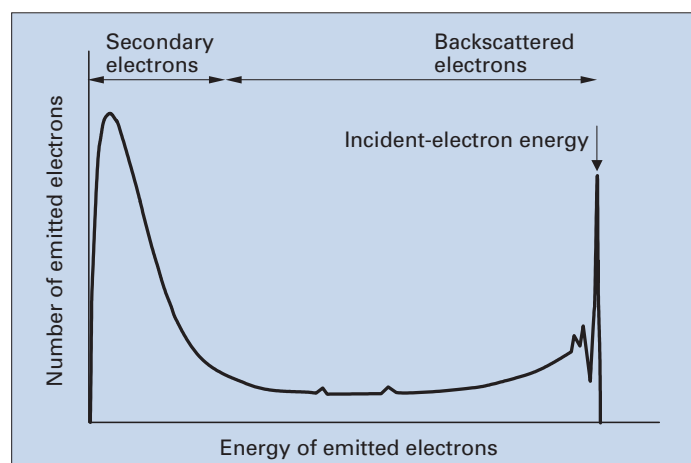

Fig. 13 Energy distribution of electrons emitted from the specimen.

Secondary Electrons

When the incident electron beam enters the specimen, secondary electrons are produced from the emission of the valence electrons of the constituent atoms in the specimen. Since the energy of secondary electrons is very small, those generated at a deep region are quickly absorbed by the specimen. Only those generated at the top surface of the specimen are emitted outside of the specimen. This means that secondary electrons are very sensitive to the surface. In addition, as shown in Fig. 14, compared to when the incident electron beam enters perpendicularly to the specimen, the amount of the secondary electron emission is larger when the electron beam enters obliquely. Figure 15 shows an actual example of the secondary electron image. The difference in the brightness of the crystal surface is due to the difference of the incidence angle of the electron beam. Thus, the secondary electron is used to observe the topography of the specimen surface. Since the secondary electron possesses a small energy, it is influenced by the potential near the specimen. As a result, an anomalous contrast arises when a specimen is electrically charged; and the secondary electron is often used to measure the operating voltage of a circuit in a semiconductor device.

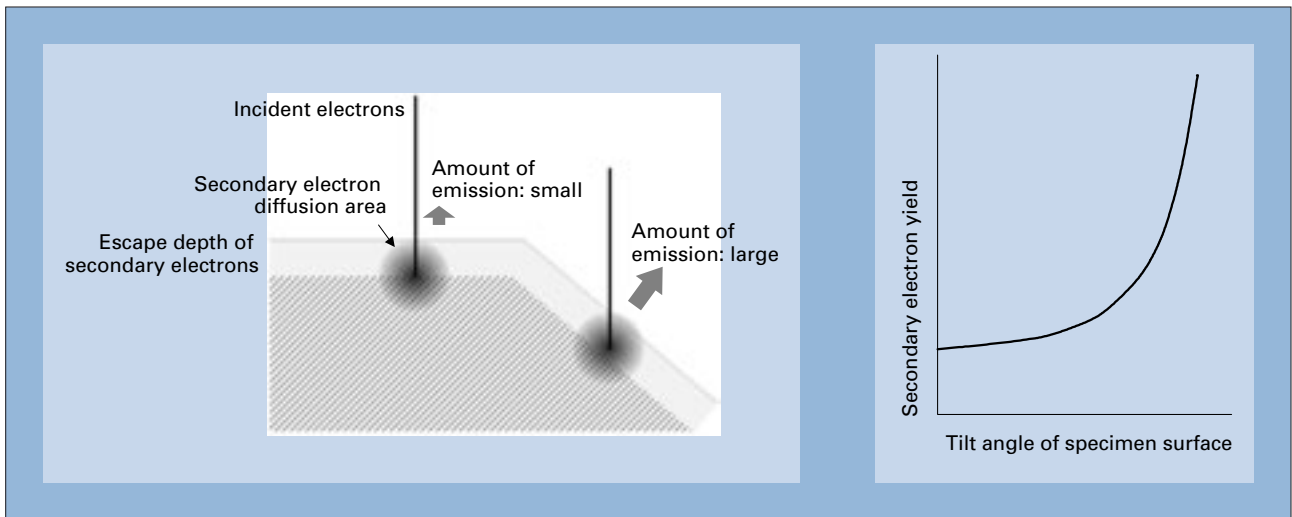

Fig. 14 Relation between the incidence angle of the electron probe and the secondary electron yield.

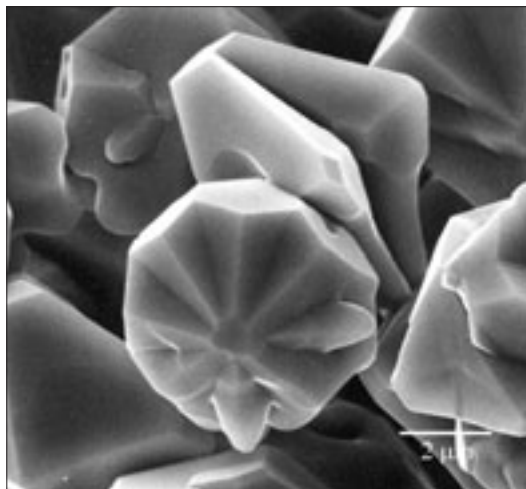

Fig. 15 Secondary electron image of tungsten oxide crystal.

Backscattered Electrons

Backscattered electrons are those scattered backward and emitted out of the specimen, when the incident electrons are scattered in the specimen. They are sometimes called reflected electrons. Since backscattered electrons possess higher energy than secondary electrons, information from a relatively deep region is contained in the backscattered electrons. The backscattered electrons are sensitive to the composition of the specimen. As shown in Fig. 16, as the atomic number of the constituent atoms in the specimen is larger, the backscattered electron yield is larger. That is, an area that consists of a heavy atom appears bright in the backscattered electron image. Thus, this image is suitable for observing a compositional difference. Figure 17 shows an actual example of a backscattered electron image. In addition, as shown in Fig. 18, if the specimen surface has irregularity, the intensity of the backscattered electrons becomes higher in the direction of specular reflection. This feature can be used to observe the topography of the surface.

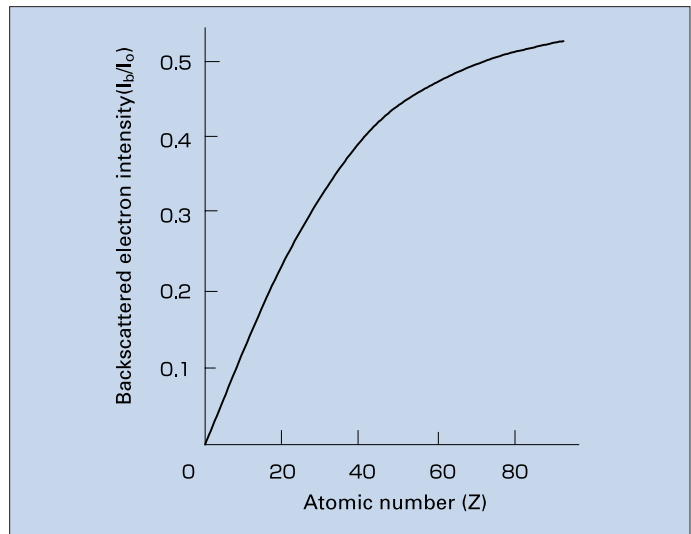

Fig. 16 Atomic number dependence of backscattered electron intensity.

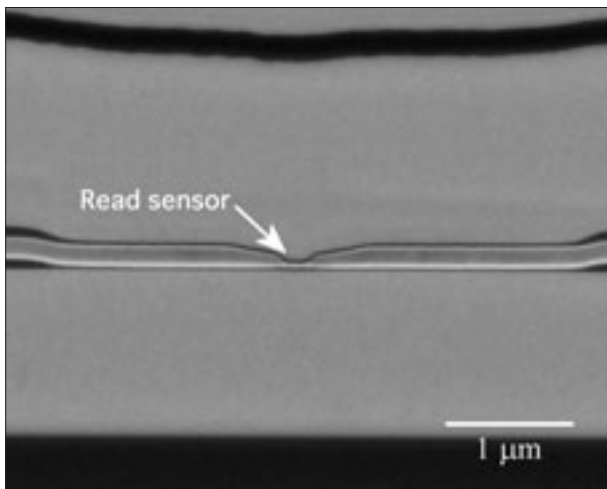

Fig. 17 Example of a backscattered electron image.
Specimen: Magnetic head for a hard disk

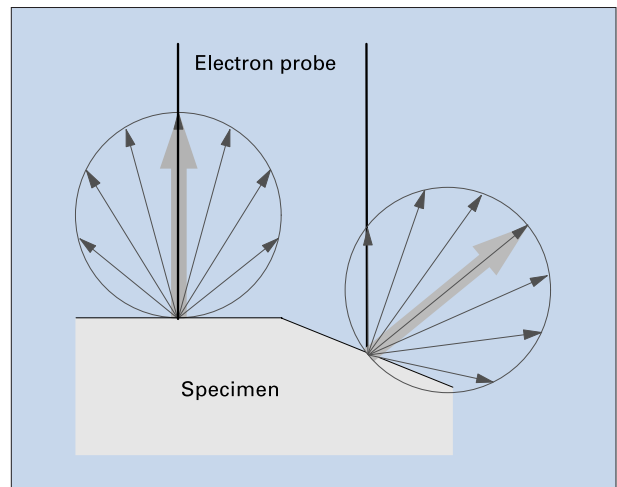

Fig. 18 Relation between the electron-probe incidence angle and the backscattered electron intensity.

As shown in Fig. 19, if an electron beam enters a crystalline specimen with a uniform composition, the backscattered electron intensity changes depending on the crystal orientation. Utilizing this phenomenon enables you to observe the difference in crystal orientation as an image. The contrast in this image is called Electron Channeling Contrast (ECC). Figure 20 shows an example. Slightly tilting the crystalline specimen causes a change in the contrast.

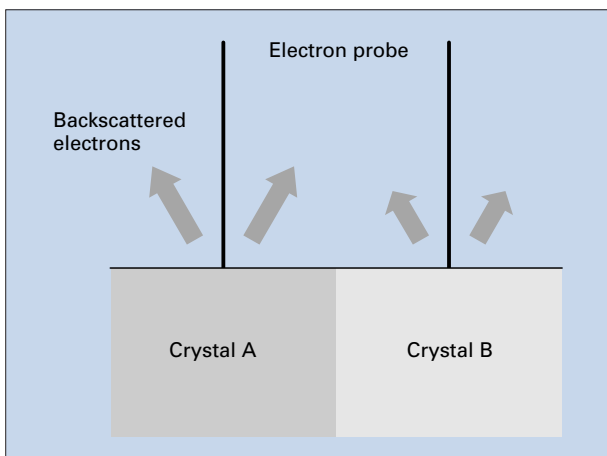

Fig. 19 Relation between crystal orientation and backscattered electron intensity.

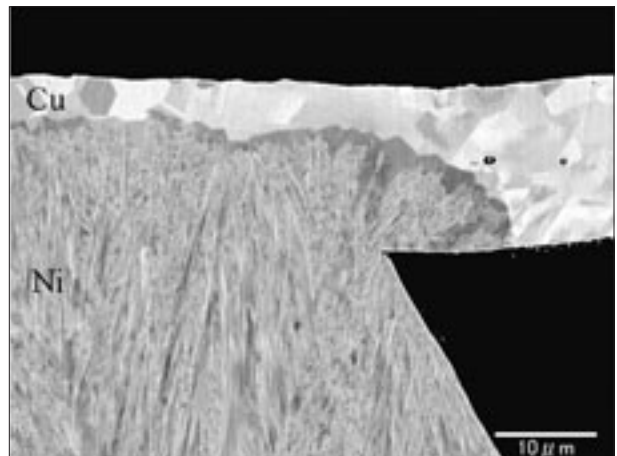

Fig. 20 Example of Electron Channeling Contrast (ECC).
Specimen: Cross section of flexible board

Edge Effect

As shown in Fig. 21, if there exists uneven steps or thin protrusions on the specimen surface, the edges of the steps or protrusions appear bright while the bright parts have a certain width (theoretically, edges should appear as sharp lines). This phenomenon is called the edge effect. Figure 22 shows the schematic diagram of this effect. Even when the electron probe irradiates the area distant from an edge on an uneven step, secondary electrons generated by the electrons diffused in the specimen are emitted from the edge surface as secondary electrons.

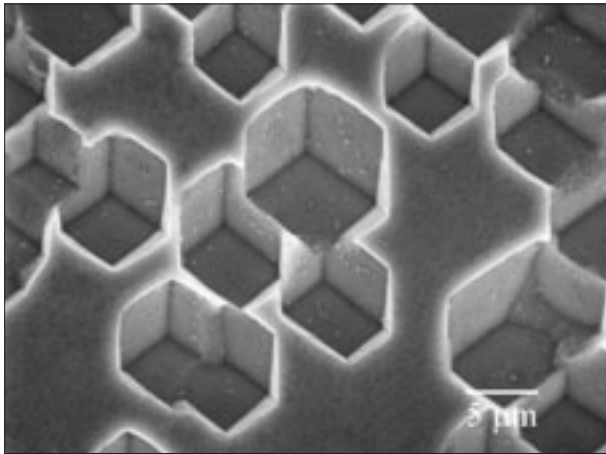

Fig. 21 Example of the edge effect.
Specimen: Etched pit on steel. Accelerating voltage: 25 kV

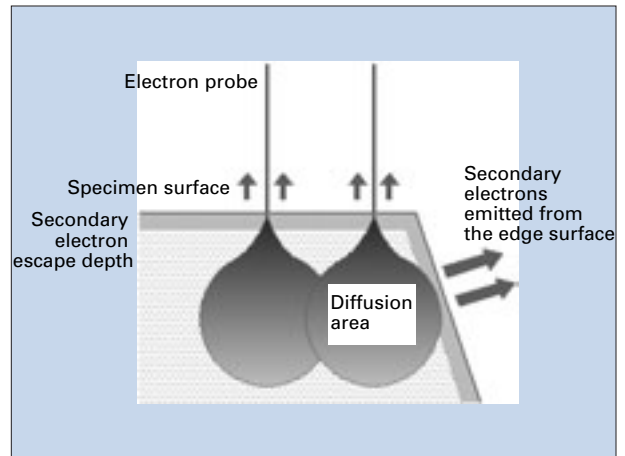

Fig. 22 Diffusion of incident electrons and resultant edge effects.

Influence of Accelerating Voltage

When the accelerating voltage is changed, the penetration depth of the incident electrons changes. As the accelerating voltage is higher, the penetration depth is larger. If the accelerating voltage is increased, information from the inside of the specimen gives rise to the background, degrading the contrast on the specimen surface. As shown in Fig. 23, the electron probe broadens within the specimen. Thus, if a structural object exists inside the specimen, a higher accelerating voltage causes an unclear image of this object that overlaps on the surface image. In addition, as the accelerating voltage is higher, the edge effect is larger. Accordingly, in order to clearly observe surface structures, it is better to use a lower accelerating voltage.

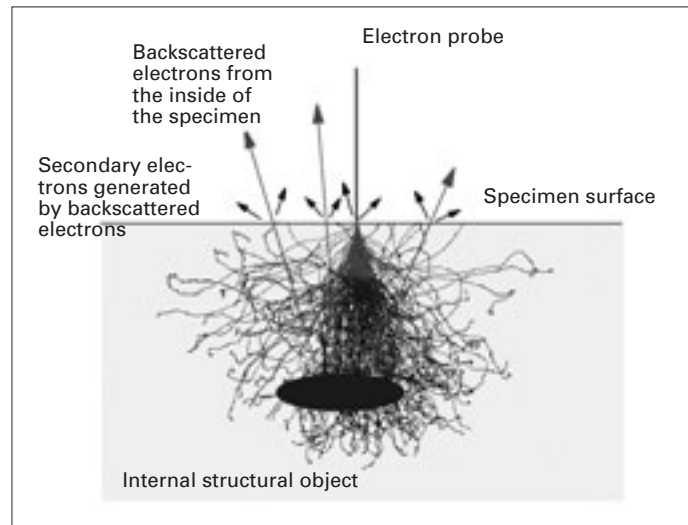

Fig. 23 Overlap of the internal structural information on the surface image.

Figure 24 shows images of plate-like crystals of boron nitride taken at three different accelerating voltages. Thin crystals of elements with small atomic number overlap each other. When the accelerating voltage is high (10 kV), crystals beneath another crystals are seen through. Two remarkable phenomena arise for floating crystals in the images. That is, parts of the floating crystals appear bright or dark. The reason for this is the following: In the former case, the secondary electrons emitted from the under side of the floating crystals are detected, contributing to a bright contrast. In the latter case, crystals located just beneath the floating crystals prevent the emission of the secondary electrons from the underside of the floating crystals. When the accelerating voltage is decreased to 1 kV, step-shaped structures on the crystals are clearly observed with sufficient contrast.

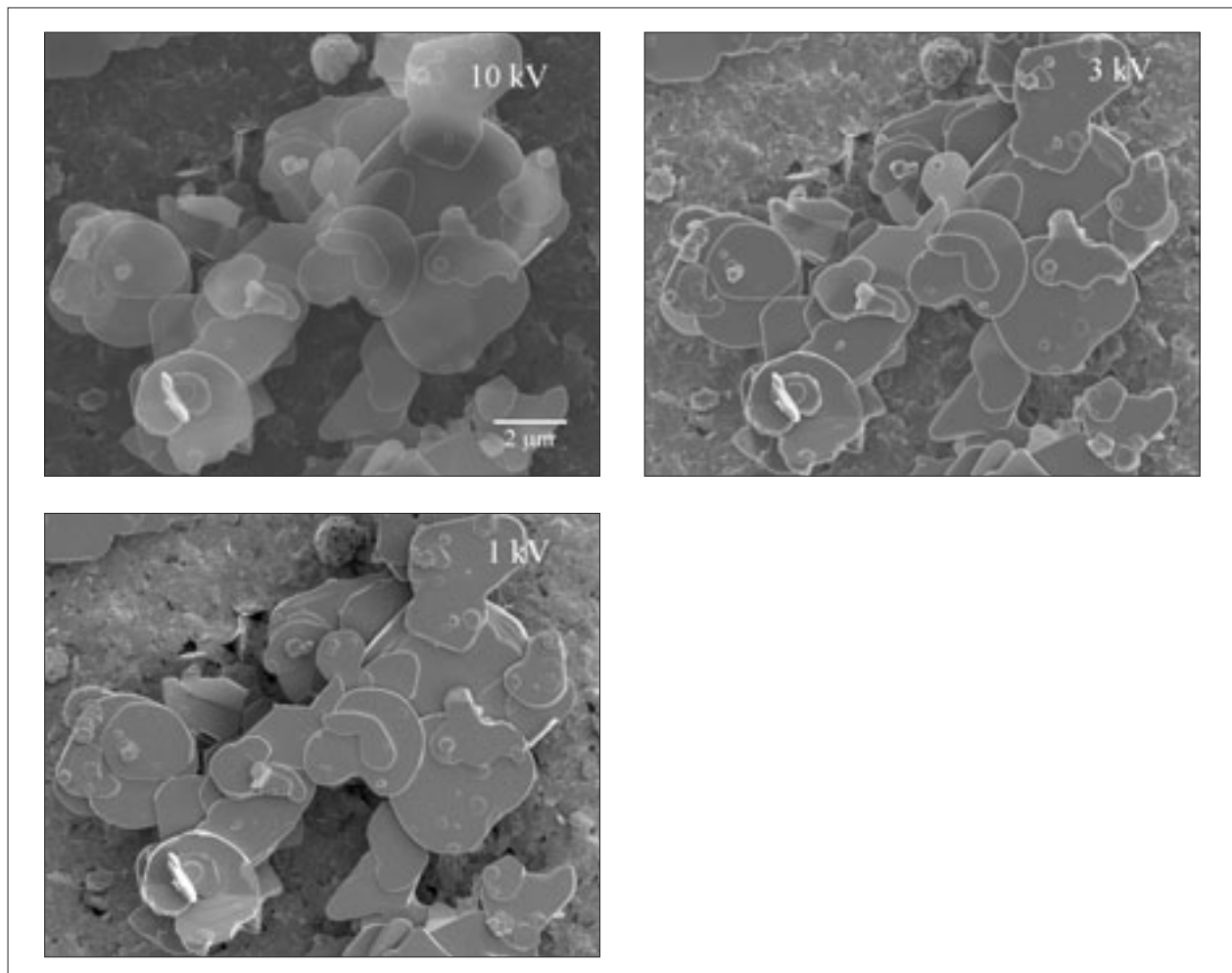

Fig. 24 Difference in the contrast of secondary electron images depending on the accelerating voltage.
Specimen: Plate-like crystals of boron nitride

Illumination Effect of Secondary Electron Detector

Theoretically, in the secondary electron image, the specimen surface perpendicular to the incident electron probe appears darker, whereas, when the specimen surface is tilted with respect to the electron probe, the image appears brighter. But actually, the position of the secondary electron detector also influences the contrast of the SEM image. Figure 25 illustrates the trajectory of the secondary electrons that enter the secondary electron detector. Secondary electrons are accelerated by a high voltage applied to the tip of the secondary electron detector and then they enter this detector. The secondary electrons emitted in the opposite direction of the detector (on the left side of the electron probe) are also attracted to the detector because their energy is very low. As the trajectory of the detected electrons causes the illumination effect, the image looks as if the specimen was illuminated with a shadow-less light. In addition, part of backscattered electrons with relatively high energies may enter the detector to produce an illumination effect having directional property. Consequently, the resultant image is seen as if soft light from the detector illuminated the specimen. The direction of the secondary electron trajectory corresponds to the illumination direction to the specimen. You may interpret the illumination effect that a pseudo light source located in front of the detector illuminates the specimen and you observe an image from the direction of the electron probe.

This effect takes place when the SEM is provided with the commonly-used E-T detector. But, when a TTL detector is used, the illumination effect changes a little. As shown in Fig. 26, the secondary electrons emitted from the specimen move along the optical axis while they are confined by the magnetic fields of the objective lens, and then they enter the detector. In this case, the direction of the secondary electron trajectory corresponds to that of the incident electron probe (observation direction). Thus, the illumination effect is weakened (less topographic contrast), and a SEM image is seen differently from the image obtained with an E-T detector.

Illumination Effect of Backscattered Electron Detector

The illumination effect also occurs for backscattered electrons. You can observe an image as if light illuminated the specimen from the backscattered electron detector. However, note that backscattered electrons enter the detector while they travel in a straight line. This is different from the secondary electron trajectory to the detector, which takes a curve. The straight trajectory of the backscattered electrons leads to a difference in the contrast depending largely on the position of the backscattered electron detector; and also strong topographic contrast is obtained. Figure 27 shows an example of the backscattered electron detector. Two detectors (A and B), which are symmetric with respect to the electron probe, are positioned just above the specimen. After the detection of the backscattered electrons, the output signals are calculated (the signal detected with detector A is taken as A, whereas that detected with detector B as B). Subtracting B from A enables you to obtain the topographic information on the specimen surface because an image becomes as if light illuminated the specimen from detector A. On the other hand, adding A and B causes the topographic information to disappear and enables you to observe a compositional difference because an image changes as if light illuminated the specimen from the electron-probe direction.

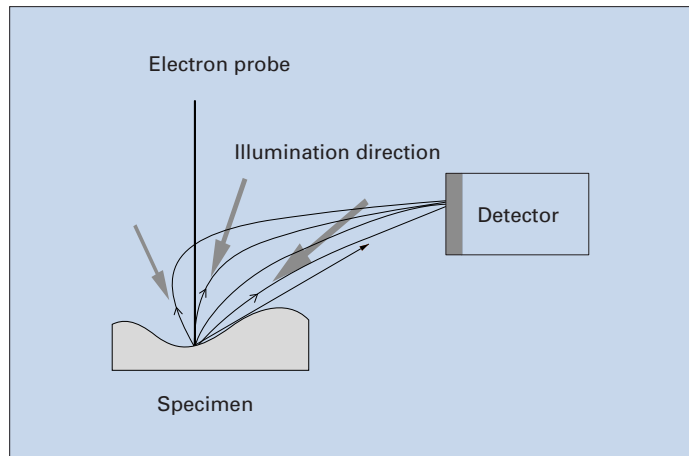

Fig. 25 Illumination effect of the commonly used E-T secondary electron detector.

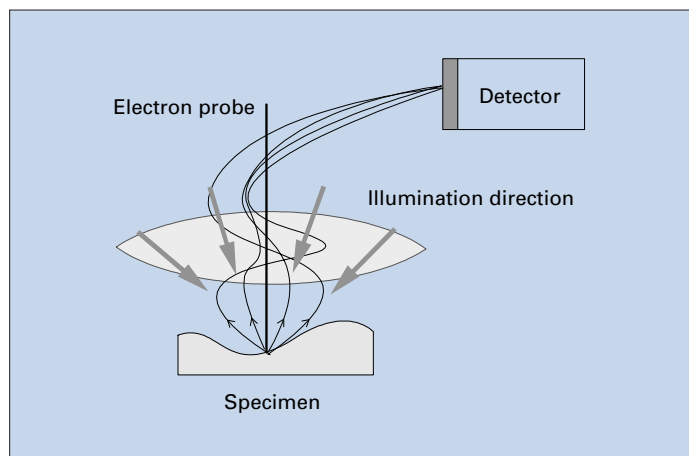

Fig. 26 Illumination effect of a TTL detector.

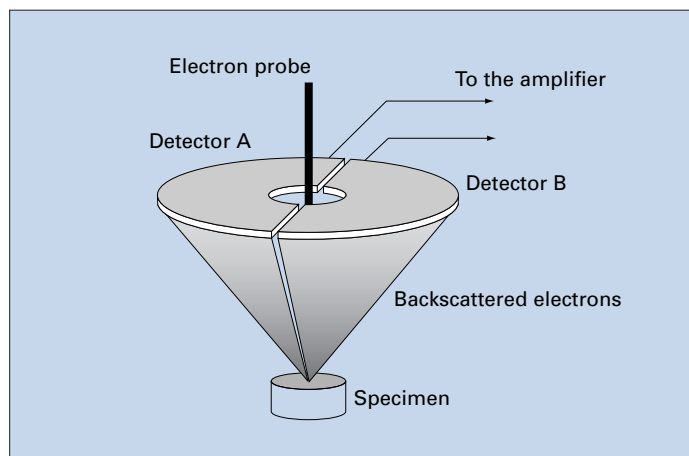

Fig. 27 Two-segment backscattered electron detector.

To Improve Image Resolution

Resolution and Resolving Power

If the electron probe is finely focused, a sharp image can be obtained. This image sharpness can be regarded as the resolving power. To be precise, the resolving power is defined as “the minimum distance that can be separated as two distinguishable points using the instrument.” Traditionally in the SEM, the resolving power is determined by measuring the minimum distinguishable distance between two objects. Figure 28 is a SEM image of gold particles evaporated on a carbon plate. As shown in arrows in Fig. 28, the distance between two particles, which are most close to each other, is measured and a resolving power of about 1 nm is obtained. In order to facilitate the measurement of resolving power, it is important to prepare a specimen that is stable and easy to observe as much as possible. A standard specimen for measurement of resolving power is different with manufacturers of electron microscopes. In addition, there are differences in measurement conditions and measurement techniques for determining the resolving power among the manufacturers.

The resolving power is obtained when the instrument is used under the optimum conditions. The “resolution” is a term similar to the resolving power. The resolution is defined as “the minimum distance that can be separated as two distinguishable points in the (SEM) image.” The resolution is determined by various factors: the status of the instrument, structures of the specimen, observation magnification, etc.

However actually, the resolution and the resolving power are often used in the same sense.

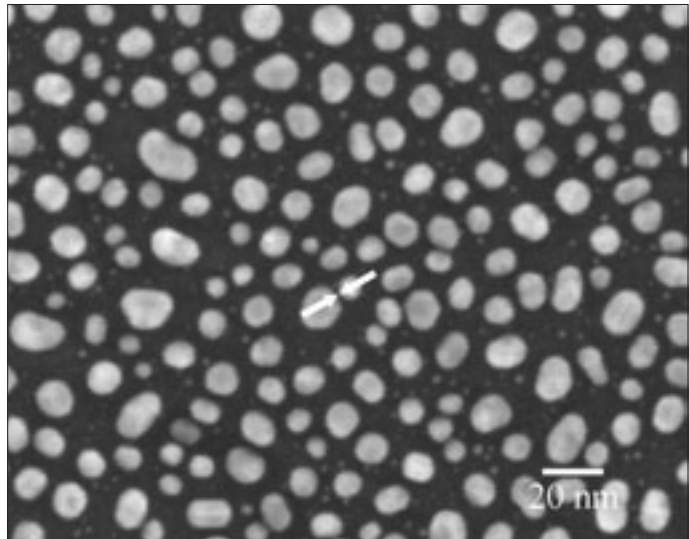

Fig. 28 Gold particles evaporated on a carbon plate. Two arrows indicate that the distance between two points are about 1 nm (resolution of 1 nm).

To Improve Resolution

The SEM resolution is determined by the diameter of the electron probe. In principle, the electron beam emitted from the electron gun is focused by the condenser and objective lenses. But in the actual operation of the SEM, the excitation of the objective lens is unchanged; therefore, the diameter of the electron probe is changed by changing the excitation of the condenser lens.

Figure 29 shows the change of the electron-probe diameter when the excitation (strength) of the condenser lens is changed. As the condenser lens is strengthened, the diameter of the electron-source image (electron probe diameter) is decreased. However, this diameter does not become smaller than the theoretical probe-size limit determined by the objective lens. Decreasing the electron-probe diameter decreases the probe current that irradiates the specimen. When the TE gun is used, as the condenser lens is strengthened, the image quality (signal-to-noise ratio) deteriorate before the electron-probe diameter reaches the theoretical limit due to the lack of the probe current, and you cannot observe an image. When using the FE gun that produces larger probe current than the TE gun, the curve in Fig. 29 shifts to the left. Thus, the electron-probe diameter reaches the theoretical limit while you can observe an image. In addition, when the performance of the objective lens is enhanced, the curve shifts downward, enabling you to obtain a much higher resolution.

Consequently, the combination of the FE gun and a higher-performance objective lens provides an extremely high resolution.

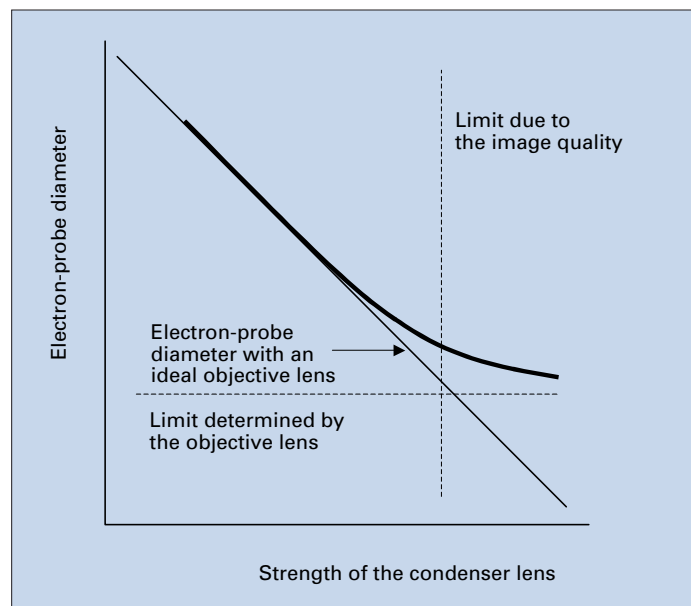

Fig. 29 Change of the electron-probe diameter when the strength of the condenser lens is changed.

Type of Electron Guns

There are three types of electron guns: TE gun, FE gun and the SE gun. This section explains the two latter guns.

Field-Emission Electron Gun

An electron gun that is used for a high-resolution SEM is the FE gun. The FE gun utilizes the field-emission effect that takes place when a high electric field is applied to a metal surface. Its construction is shown in Fig. 30. The cathode is made of a thin tungsten wire. A tungsten single crystal is welded to this tungsten wire, and the tip of the tungsten single crystal is shaped to be a curvature radius of about 100 nm. This is called the emitter. When a positive voltage (a few kV) is applied to a metal plate (extracting electrode), the tunneling effect occurs and electrons are emitted from the emitter. If a hole is made at the center of the extracting electrode, the emitted electron beam flows through this hole. Then, when you apply a voltage to the electrode (accelerating electrode) located below the extracting electrode, you can obtain an electron beam having certain energy. In order to generate a field emission, the tip of the emitter must be very clean. Thus, the FE gun needs to be placed in an ultrahigh vacuum of about 10^{-8} Pa.

The electron beam emitted from the emitter behaves as if the beam was emitted from a small electron source with a diameter of 5 to 10 nm. In the case of the TE gun, its electron source is 10 to 20 μm in diameter, indicating that the FE gun produces a much smaller electron source than the TE gun, thus suitable for high-resolution SEMs. In addition, another advantage of the FE gun is that the energy spread of the electron beam is small because the FE gun requires no heating of the emitter. In low-accelerating voltage observation, this energy spread determines the resolution (chromatic aberration); therefore, this advantage is very important.

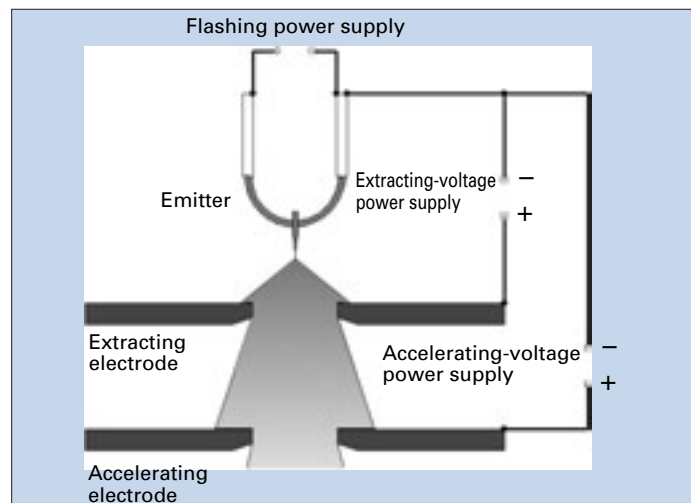

Fig. 30 Construction of the FE gun.

Schottky-Emission Electron Gun

The SE gun utilizes the Schottky-emission effect that takes place when a high electric field is applied to a heated metal surface. Its construction is shown in Fig. 31. The cathode is a ZrO/W emitter. That is, a tungsten single crystal coated with ZrO, which has a tip curvature radius of a few hundred nanometers. Coating of ZrO greatly decreases the work function, thus a large emission current can be obtained at a relatively low cathode temperature of about 1800K. As shown in Fig. 31, in order to shield the thermoelectrons from the emitter, a negative voltage is applied to an electrode, called the suppressor. An advantage of the SE gun is that the electron-beam current is highly stable because the emitter, which is placed in an ultrahigh vacuum of about 10^{-7} Pa, is kept at a high temperature and no gas-absorption occurs.

Compared to the FE gun, the energy spread of the electron beam is somewhat larger, but the SE gun produces larger probe currents. Thus, these features are very effective for various analyses simultaneously with morphological observation. This electron gun is often called the thermal-cathode FE gun or thermal FE gun for convenience.

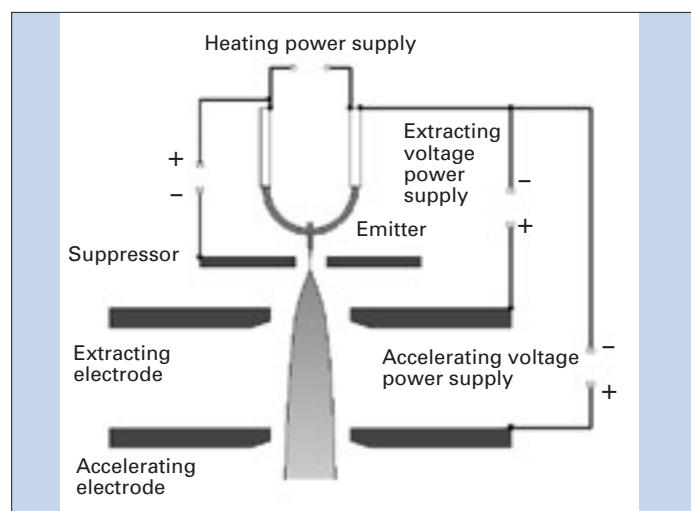

Fig. 31 Construction of the SE gun.

Features of Three-Type Electron Guns

Figure 32 is a radar chart compares the features of the TE gun, FE gun and SE gun. The FE gun is superior in terms of the electron-source size, brightness (quantity that means the current density and parallelity of the electron beam), lifetime and energy spread (energy width) of the electron beam. The TE gun is superior in terms of the probe current and current stability. Considering these features, the FE gun is suitable for morphological observation at high magnifications, and the TE gun is suitable for versatile applications such as analysis that does not require high magnification. The SE gun is situated between these two electron guns and its applications ranges from high-magnification observation to various analyses.

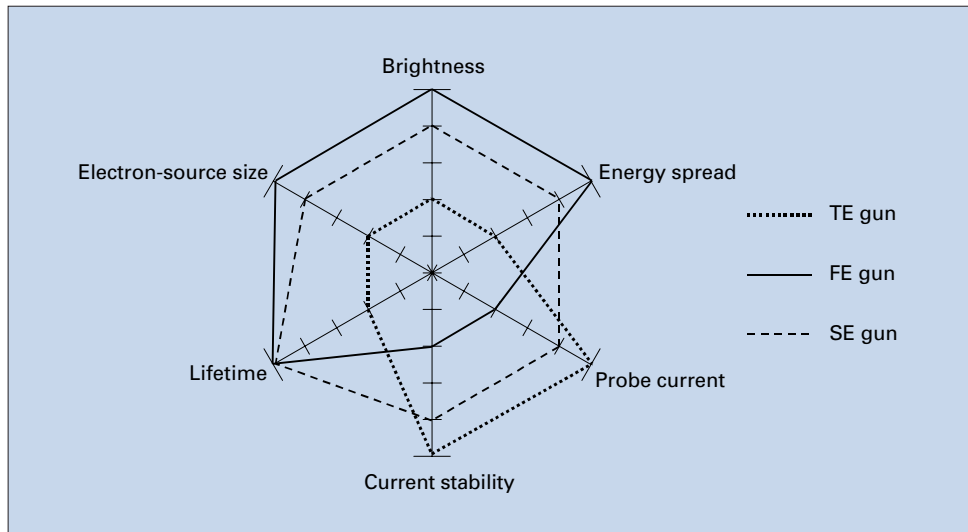

Fig. 32 Comparison of three-type electron guns.

Table 1 summarizes the features of these electron guns.

Table 1 Features of three electron guns.

	TE gun		FE gun	SE gun
	Tungsten	LaB ₆		
Electron-source size	15 ~ 20 μm	10 μm	5 ~ 10nm	15 ~ 20nm
Brightness (Acm ⁻² rad ⁻²)	10 ⁵	10 ⁶	10 ⁸	10 ⁸
Energy spread (eV)	3 ~ 4	2 ~ 3	0.3	0.7 ~ 1
Lifetime	50 h	500 h	Several years	1 to 2 years
Cathode temperature (K)	2800	1900	300	1800
Current fluctuation (per hour)	<1%	<2%	>10%	<1%

Note that the brightness is obtained at 20 kV.

Types and Capabilities of Objective Lenses

The objective lens is the final-stage lens to produce the electron probe. This is an important component that determines the SEM resolution. Here, the relation between the objective-lens capabilities and resolution is presented. In the ideal lens, the electron beam emitted from a point converges to a point after passing through the lens. But in the actual lens, the electron beam does not form a point, which has a blur. This blur is called "aberration." The lens aberration consists of various aberrations such as spherical aberration, chromatic aberration and diffraction aberration. In order to decrease the spherical aberration, the aperture angle of the lens is decreased, that is, only the beam near the optical axis is used; however, this increases the diffraction aberration. Thus, the minimum diameter of the electron probe is determined by the optimum aperture angle that takes account of the balance of these aberrations. Figure 33 shows the relation between the objective-lens aberrations and the electron-probe diameter. Note that when the accelerating voltage is lower, the influence of the chromatic aberration becomes larger; therefore, this must be taken into consideration.

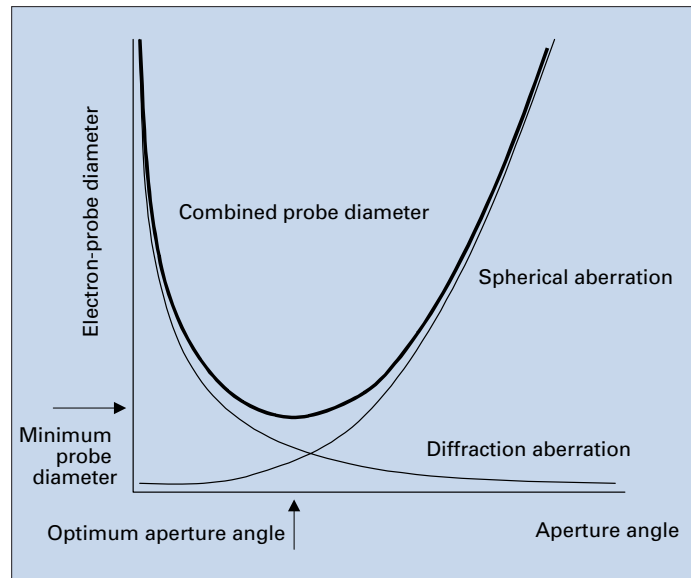

Fig. 33 Objective-lens aberrations and electron-probe diameter.

Figure 33 shows the relation between the objective-lens aberrations and the electron-probe diameter. Note that when the accelerating voltage is lower, the influence of the chromatic aberration becomes larger; therefore, this must be taken into consideration.

Conventional Objective Lens

The conventional objective lens is also called the out-lens objective lens. This lens is used for most electron-probe instruments including Electron Probe Microanalyzers (see page 28). As shown in Fig. 34, a specimen is placed below the objective lens, in order to prevent the interference of the specimen and the lens even if a large specimen is tilted. This lens allows the specimen to be handled freely, but the distance between the specimen and the lens should be long, requiring a long focal length. Therefore, the aberration becomes large and a high resolution cannot be obtained.

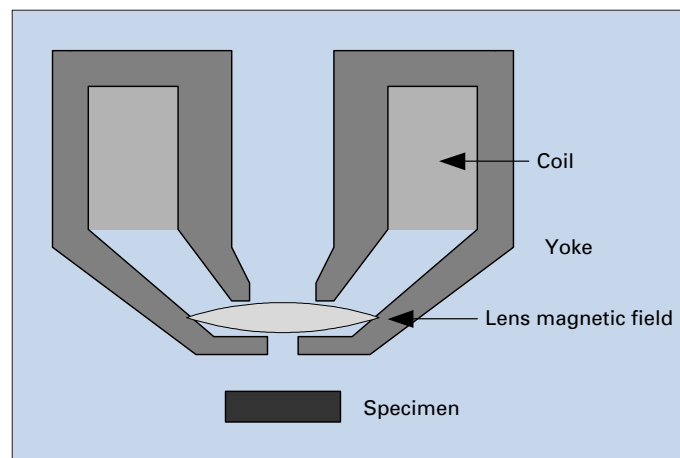

Fig. 34 Construction of the conventional objective lens.

Strongly Excited Objective Lens for High Resolution

This lens aims at obtaining high resolution by shortening the specimen-lens distance and enhancing the lens performance. The distance is shortened by placing the specimen in the lens magnetic field. There are two types of lenses available for this purpose: the in-lens objective lens and semi-in-lens objective lens (also called snorkel objective lens). Figure 35 shows the construction of the in-lens objective lens. The specimen is inserted into the magnetic field between the polepieces of the objective lens, as in the case of the transmission electron microscope (TEM). The specimen size is limited to a few millimeters. Figure 36 shows the construction of the semi-in-lens objective lens. To overcome the limit of the specimen size in the in-lens objective lens, the shape of the polepieces is designed to produce the lens magnetic field below the space of the objective lens by leaking a strong magnetic field to this space. Thus, a large specimen can be handled with the semi-in-lens objective lens. In these two lenses, the secondary electron detector is placed above the objective lens; therefore, the image contrast is different from that in the conventional objective lens (see page 14).

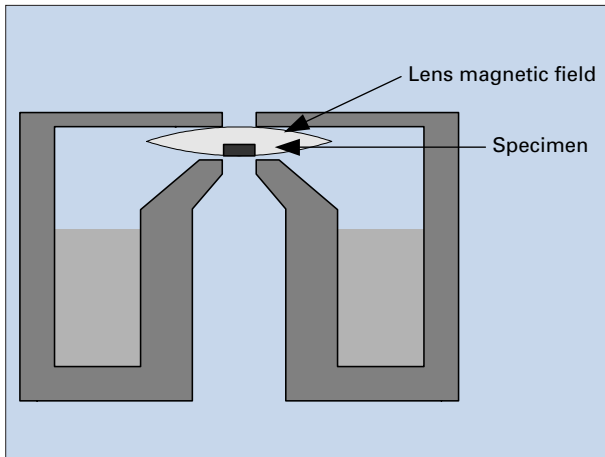

Fig. 35 Construction of the in-lens objective lens.

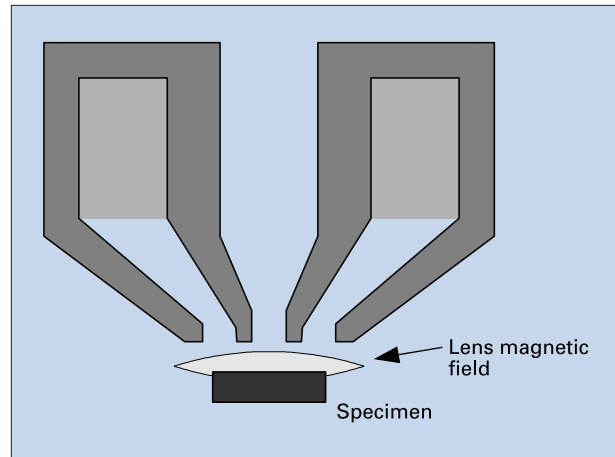

Fig. 36 Construction of the semi-in-lens objective lens.

Role of Objective Lens Aperture

If the entire opening of the objective lens is used, a fine electron probe cannot be produced due to the lens aberration. To avoid this, the "aperture," which is a thin metal plate having a small hole is used to enable the electron beam to pass only through the center of the objective lens. If this objective lens aperture is displaced from the center, the aberration of the objective lens becomes large, making it impossible to form a fine electron probe. Therefore, the objective lens aperture must be placed exactly on the optical axis.

Actual Resolution of SEM

Figure 37 shows the relation between the accelerating voltage and the resolution in actual SEMs. The resolutions of three types of SEMs, the general-purpose SEM, general-purpose FE-SEM (SEM with FE gun) and ultrahigh resolution FE-SEM, are presented. In any SEM, as the accelerating voltage is higher, the resolution is higher. When the accelerating voltage is decreased down to a few kV or below, the resolution is drastically degraded. The decrease of the resolution in low accelerating voltages is caused by the influence of the chromatic aberration. Note that the resolution curve for the SEM with an SE gun is almost the same as that for the general-purpose FE-SEM.

- General-purpose SEM : TE gun + Conventional objective lens
- General-purpose FE-SEM : FE gun + Conventional objective lens
- Ultrahigh resolution FE-SEM : FE gun + Objective lens for high resolution

Figure 38 shows the relation between the probe current and the probe diameter at 20 kV accelerating voltage. In the SEM with a TE gun, increasing the probe current increases the probe diameter with a relatively uniform curve. On the other hand, in the SEM with an FE gun, even when the probe current is increased, the probe diameter is relatively constant in a certain range; however, the probe diameter drastically increases at a probe current of about 1 nA. In addition, the FE gun cannot produce a probe current larger than few nA. In the SEM with an SE gun, a much larger probe current can be obtained and also, the increase of the probe diameter is not drastic. Thus, the SE gun is suitable for analytical purposes.

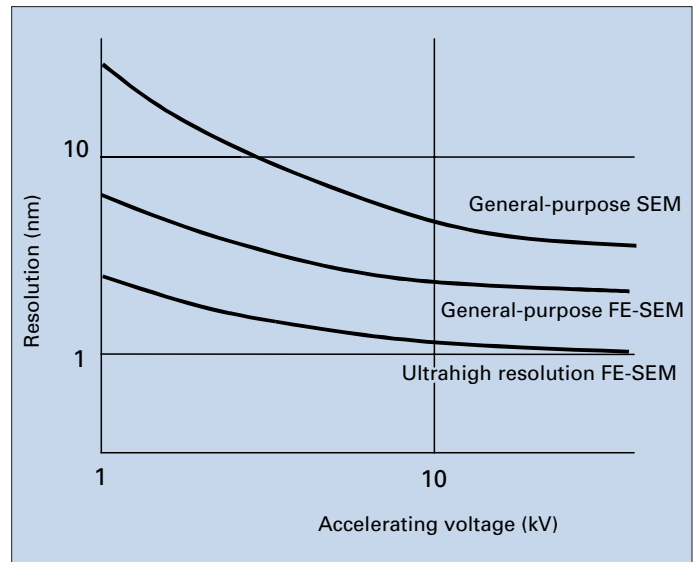

Fig. 37 Relation between the accelerating voltage and the resolution.

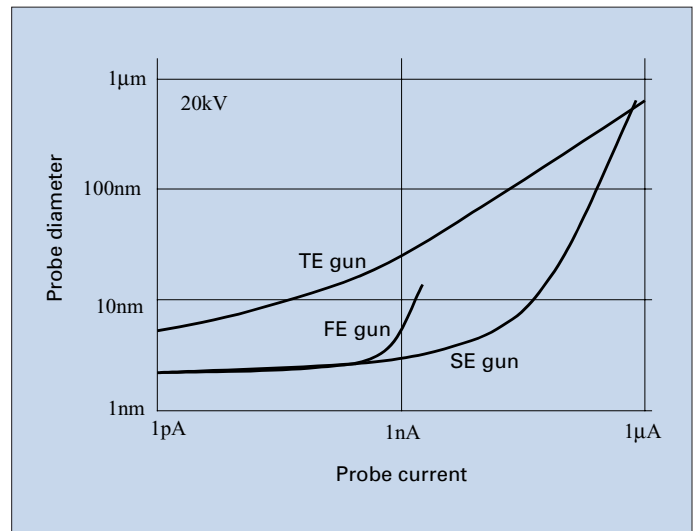

Fig. 38 Relation between the probe current and the probe diameter.

Charging and Its Influence

What is Charging?

As explained before, the electrons that entered the specimen lose their energy and they are absorbed in the specimen. If a specimen is conductive, the electrons flow through the specimen stage; however, if a specimen is nonconductive, the electrons stop in the specimen. That is, the charging occurs. Figure 39 is the schematic illustration of the charging. In this case, the number of the electrons flowing to the specimen is not equal to that exit from the specimen. In general, the number of the electrons flowing to the specimen is larger and the specimen is negatively charged. If the irradiation of the electron beam is continued, a negative charge is accumulated in the irradiated point, resulting in a large negative potential in this point. If the electron-beam irradiation is continued further and the negative potential exceeds a certain value, discharge occurs and the potential returns to its original potential. On the other hand, if some reason causes the number of the electrons exiting from the specimen to be larger than that flowing to the specimen, the specimen is positively charged.

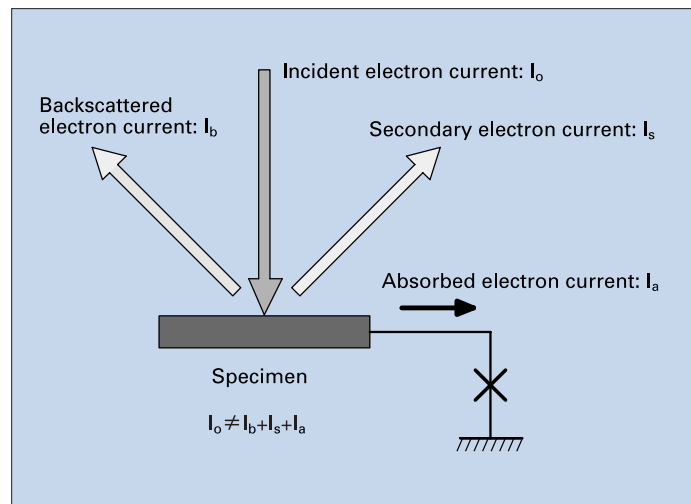

Fig. 39 Electric flow in a nonconductive specimen.

Influence of Charging on SEM Image

If the charging occurs, the electron probe that scans over the specimen is deflected by the repulsive force from a charged potential, resulting in a positional shift of the electron probe. This causes an image to distort. In addition, if discharge occurs, the electron probe returns to its original position for a moment. As a result, a SEM image appears as if the image was broken away, as shown in Fig. 40.

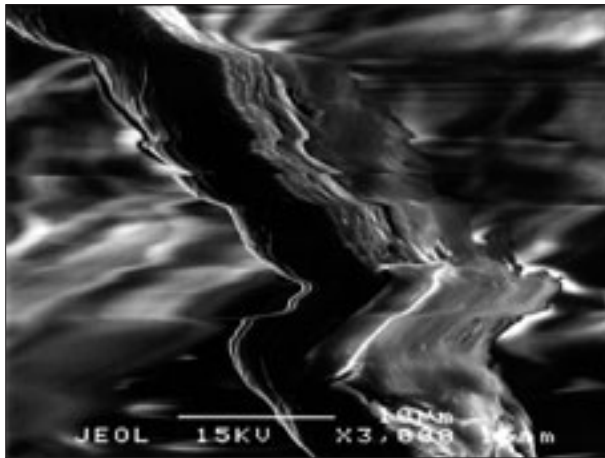

Fig. 40 Distortion of a SEM image caused by the charging.

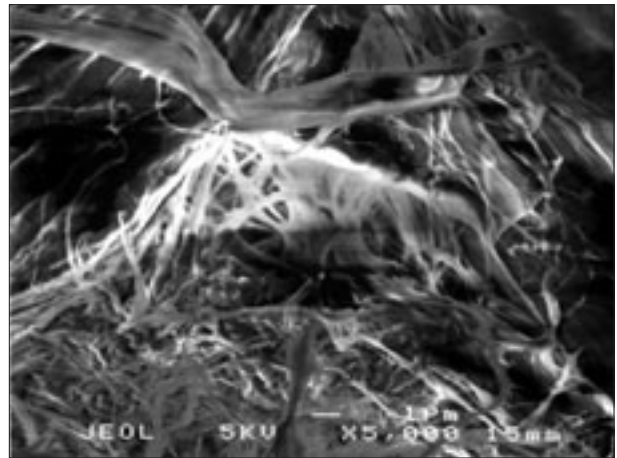

Fig. 41 Anomalous contrast due to the charging.

If the charging is very small and the electron-probe scan is not affected, what happens? In such a case, secondary electrons with a small energy are influenced by a local charging. The influence gives rise to a difference in the detection efficiency of secondary electrons or disturbance of the secondary electron trajectory. As a result, part of the image appears bright or dark. The difference in the detection produces a so-called voltage contrast. That is, if the specimen is negatively charged, the voltage difference between the secondary electron detector and the specimen becomes large and therefore, more secondary electrons enter the detector, causing the locally-charged area to be observed bright (high detection efficiency). Whereas, if the specimen is positively charged, the detection efficiency becomes low, leading the locally-charged area to be observed dark. Local charging generates a high electric field surrounding the locally-charged area. This electric field is higher than that generated by the secondary electron detector. Therefore, the secondary electrons emitted from the specimen are deflected by this high electric field, giving rise to disturb the secondary electron trajectories. As a result, the secondary electrons do not enter the detector and part of the image appears dark. Figure 41 shows this phenomenon.

To Prevent Charging

●Coating

The most typical method to prevent the charging is conductive coating. This method coats a nonconductive specimen with a highly-conductive thin metal film. Ion sputtering and vacuum evaporation are included in this method. A thin film with a thickness ranging from a few to 10 nm of a noble metal (for example, Au, Pt, Au-Pd, Pt-Pd) is coated on the specimen. The reason for using a noble metal is that it is highly stable and its secondary-electron yield is high. In order to reproduce the true surface of the specimen, it is necessary to prepare a thin film. However, if a surface has a complicated morphology, too thin coating may cause charging because the coating film loses its continuity.

●Low accelerating-voltage observation

In the case when a specimen is charged, the number of the electrons flowing to the specimen is different from that which exit from the specimen. As the accelerating voltage of the incident electron beam is decreased, the secondary-electron yield is increased as shown in Fig. 42. At an accelerating voltage of around 1 kV, the number of the emitted secondary electrons is larger than that of the incident electrons. By using such a low accelerating voltage, the number of the electrons flowing to the specimen becomes equal to that which exit from the specimen. This means that the specimen is not charged. Thus, even a nonconductive specimen can be imaged without any charging. Figure 43 is an example of images of ceramics without coating. At an accelerating voltage of 10 kV, there is little topographic information and some anomalous tailing appears on the image. But in an accelerating voltage of 1 kV, substantial topographic information is obtained and also, no tailing appears in the image.

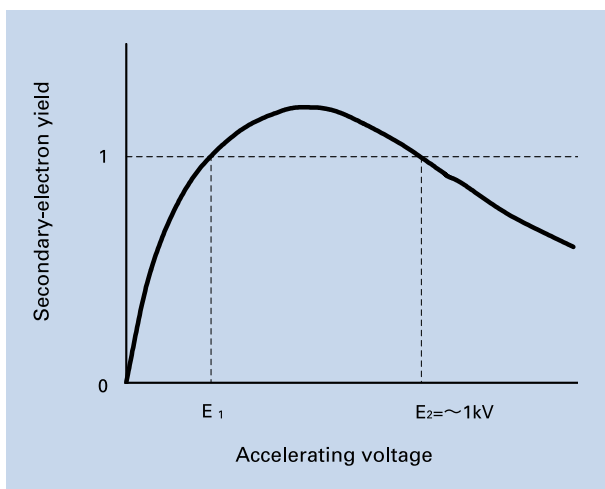

Fig. 42 Relation between the accelerating voltage and the secondary-electron yield.

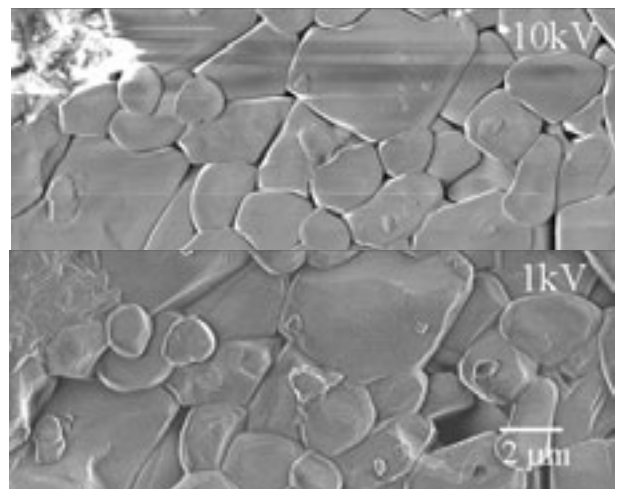

Fig. 43 Secondary electron images of ceramics at different accelerating voltages (no coating).

●Tilt observation

As explained before (see page 10), when the electron beam enters obliquely to the specimen, the number of the emitted secondary electrons is increased. Utilizing this phenomenon enables you to observe a nonconductive specimen without any charging. This technique is effective for the observation of a specimen with less surface irregularity.

● **Low vacuum SEM observation**

When you use the low vacuum SEM (LVSEM) explained later (see page 26), you can observe a nonconductive specimen without any coating. Decreasing the vacuum in the specimen chamber increases the number of the residual gas molecules. These gas molecules are ionized by the electrons and reach the specimen as positive ions to neutralize the charging (Fig. 44). In order to produce a sufficient number of the positive ions for charge neutralization, it is necessary to set the pressure in the specimen chamber to a few tens to 100 Pa (this value may be different depending on the specimen). Figure 45 shows an example of images of a shell of Foraminifera without coating, taken with an LVSEM. An anomalous contrast arises due to the charging in the high-vacuum mode, but this contrast disappears in the low-vacuum mode. Note that the latter image is backscattered electron image; therefore, strong shadowing effect is observed.

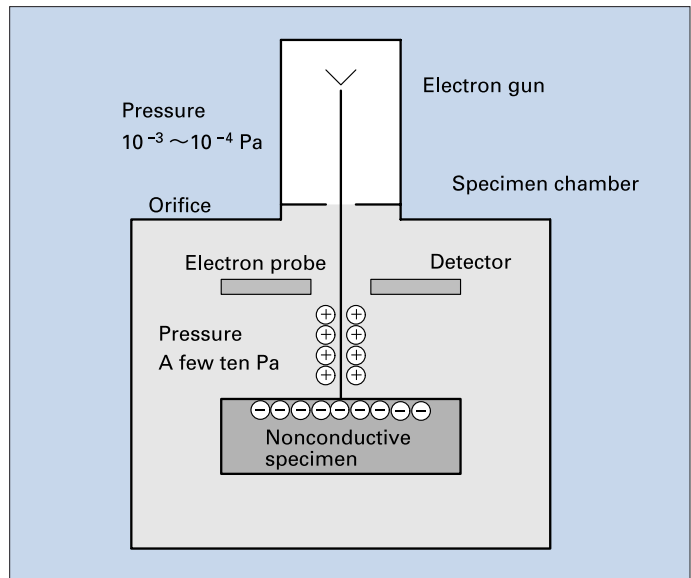

Fig. 44 Schematic diagram illustrating the principle of the LVSEM for observation of nonconductive specimens.

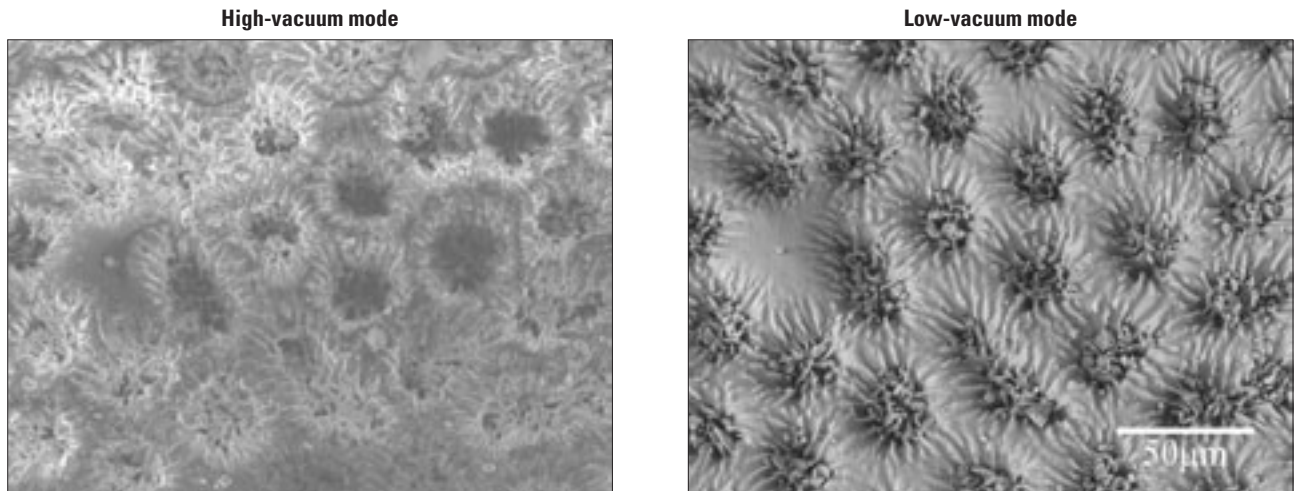

Fig. 45 Example of images of a nonconductive specimen taken with LVSEM.

Specimen: Shell of Foraminifera (no coating)

Basics of Specimen Preparation

The specimen must meet the following requirements before it is loaded to the SEM stage: a) The surface to observe is exposed. b) The specimen is firmly fixed to the specimen mount. c) The specimen has conductivity in principle.

Exposing Surface to Observe and Contrast Enhancement

After cutting the specimen with a suitable size for observation, expose a surface to observe. In principle, when you want to observe the specimen surface itself, special treatment is not required. But if necessary, you are required to remove films that may prevent observation.

When you want to observe internal structures, it is necessary to prepare a cross section. Actual methods are as follows.

●Fracturing

If a specimen is hard, it is fractured to prepare a cross section. When a specimen is a structural object, such as semiconductor device that is grown on a Si or GaAs single crystal, it has a cleavage property in a specific direction of the crystal; therefore, fracturing the specimen in this specific direction enables you to obtain a flat cross section. If a specimen is soft at normal temperature but hard at low temperature, freeze fracturing is applied to this material in liquid nitrogen.

●Cutting

If a specimen is soft like a polymer, it can be cut using an ultramicrotome, which is originally used to prepare a thin section for a TEM. A cross section planed off by this method is very flat. When only a low-magnification observation is performed, a specimen with a few scars may be acceptable. In such a case, a razor blade is used for cross-section preparation.

●Mechanical polishing

For many metal or mineral specimens, mechanical polishing is applied. In this method, a specimen is embedded in a resin and polished. In the mechanical polishing process, abrasives are gradually changed from rough to fine abrasives and finally, a polished cross section is fabricated to a mirrored surface.

●Milling by the ion beam

In recent years, the use of ion-beam milling has been increasing. For example, a focused ion beam (FIB) system enables you to obtain a cross section with a high positional accuracy of a few hundreds of nanometers. In addition, the broad ion-beam milling technique is available, which uses a broad Ar ion beam for cross-section preparation. Compared to FIB, the positional accuracy of this technique is lower, but this technique provides a much wider cross section.

●Contrast enhancement

In many specimens, secondary electron images provide no contrast when their cross sections are very smooth. In these cases, various contrast-enhancement techniques are applied. Two examples are explained. The first is selective etching. Surfaces of cross sections are chemically or physically etched to form irregularity on the surface and internal structures are observed using secondary electron images. The second is called "staining." Specific areas of a high polymer specimen are stained by heavy metals, such as Os and Ru, and its compositional image is observed by using backscattered electron images. On the other hand, even when such specimen treatment (contrast enhancement) is not applied, if an original specimen has a difference in composition or crystalline property, a compositional image or an ECC image can be observed in backscattered electron mode.

Mounting Specimen

The specimen must be stably fixed to the specimen mount. In addition, the specimen must electrically connect to this specimen mount.

●Bulk specimens

Bulk specimens are fixed to the specimen mount by conductive paste or conductive double-sided adhesive tape. If a bulk specimen has a relatively uniform shape, it is clamped with an exclusive specimen holder. If a bulk specimen is nonconductive, it should be coated by conductive paste as wide as possible while keeping an area to observe.

●Powders and particles

These specimens are dusted on conductive paste or double-sided adhesive tape. In dusting powders or particles, they must disperse as wide as possible. On the other hand, some specimens can be subjected to the suspension method. In this method, specimens are suspended in the dispersion medium (organic solvent, water, etc.) and they are dropped on an aluminum foil or a Si wafer, and finally they are dried.

Coating

If a specimen is nonconductive, its surface needs to be coated with a thin metal film so that the surface has conductivity. This technique is called coating, and ion sputtering and vacuum evaporation are typical methods.

Ion sputtering is classified into two techniques. The first technique uses an ion-sputter coater and the second one uses an ion-beam sputter coater. In general, the first technique (ion-sputter coater using diode sputtering) is used. In the ion-sputter coater, positive ions, which are produced by discharge in a low vacuum of about 10 Pa, sputter a target metal and the specimen is coated with the sputtered target metal. Figure 46 shows the schematic diagram of the ion-sputter coater. Since the inside of this device is kept at a low vacuum, the particles of the sputtered target metal collide with many residual gas molecules; therefore, the metal particles are strongly scattered and attached to the specimen surface from every direction, forming a uniform film on the surface. On the other hand, when the ion-beam sputter coater is used, a high-quality thin film is formed because both the target and specimen are placed in a high vacuum.

Vacuum evaporation heats and vaporizes a material, forming a thin metal film on the specimen surface. Since the inside of the vacuum evaporator is a high vacuum of about 10^{-3} Pa, the number of the residual gas molecules in the device is small, causing the scattering of the evaporated material particles to be weak. As a result, the specimen surface cannot be coated with the evaporated material from every direction. In order to form a uniform film on the surface, the specimen is rotated and tilted.

As a coating material, a noble metal (Au, Au-Pd, Pt, Pt-Pd, etc.) is used because it is stable and has a high secondary-electron yield. For high-magnification observation, Au-Pd, Pt or Pt-Pd is used. For some cases including elemental analysis, C or Al may be used. Pt and Pt-Pd are difficult to evaporate in vacuum. C and Al are difficult to sputter.

If a coated film is thick, this hides fine structures on the specimen surface; therefore, a thinner film is desirable. However, if the film is too thin, it may cause charging because the coating film loses its continuity. In general, a coated film is prepared to be a few to 10 nm in thickness.

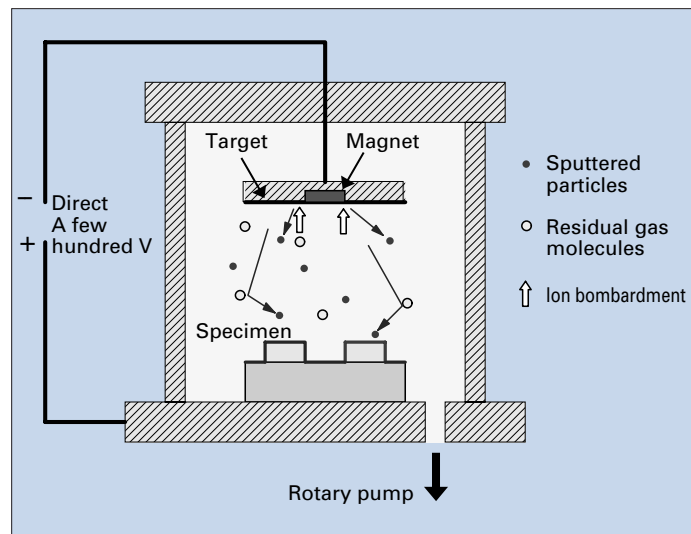

Fig. 46 Principle of the ion-sputter coater.

Treatment of Biological Specimen

Water-containing specimens, such as biological tissues, are deformed if they are transferred to the SEM specimen chamber without any pre-treatment. In order to prevent the deformation, biological specimens are generally subjected to the following procedure, and then they are observed with their surfaces coated. Foods are also subjected to a process similar to the following procedure.

● Removing and cleaning of tissues

In this process, a tissue is cut to make it with an appropriate size so that it can be preserved until the drying process. In order to prevent the deformation of the tissue, sufficient care is needed. Cleaning of its surface may be also necessary.

● Fixation

Since a removed tissue starts to change its structure after its death, in order to prevent this change, it is chemically fixed by chemicals such as glutaraldehyde, formaldehyde, and osmium tetroxide. In this process, adsorbing much osmium metal to the tissue may give conductivity to the tissue (conductive staining). For some tissue specimens, rapid freezing (called physical fixation) is used to suppress a structural change of the tissue.

● Dehydration

In the dehydration process, to prevent the deformation, the specimen is immersed in an ethanol or acetone solution for a certain period of time while the concentration of the solution is changed in several steps.

● Drying

Ethanol or acetone in the tissue specimen is removed and then, this tissue is dried. If natural drying is applied, a surface-tension effect deforms the specimen. Thus, a special drying method, critical-point drying or freeze drying for example, is used.

● Mounting and coating of specimen

This process is the same as that for other nonconductive specimens.

Low Vacuum SEM

In a normal SEM, the pressure inside the specimen chamber is kept at 10^{-3} to 10^{-4} Pa. But, in an LVSEM, this pressure can be set to several tens to several hundreds Pa. In order to maintain a high vacuum in the electron gun chamber, an orifice is generally placed between the electron-beam path and the specimen chamber (see p23). If the E-T detector is used in vacuum in the LVSEM, discharge occurs; therefore, the backscattered electron detector is used. The use of the backscattered electron detector may enhance the compositional contrast and provide a SEM image with strong shadowing effect, thus sometimes, an ion-current detection technique is used, which utilizes gas amplification of secondary electrons in low vacuum.

We already explained that the LVSEM is used for observation of nonconductive specimens without coating. In addition, utilizing the fact that the pressure in the specimen chamber can be increased, the LVSEM is used for observing specimens with a lot of outgassing, unstable specimens in high vacuum and frozen water-containing specimens.

If you try to observe a porous specimen with a lot of outgassing in a normal SEM, it takes a lot of time to decrease the pressure (for higher vacuum) in the specimen chamber, thus you have to wait for a while until observation. To the contrary, the LVSEM can be used even if the vacuum in the specimen chamber is several tens to several hundreds Pa, thus effective for observing such a specimen in a short time.

Figure 47 is an example of an LVSEM image taken from a concrete piece with a lot of outgases. In this observation, the time to obtain a SEM image was only a few minutes.

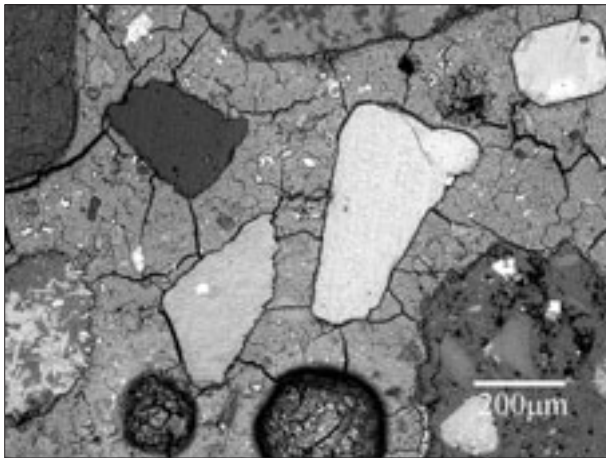

Fig. 47 Observation example of a concrete piece using LVSEM.

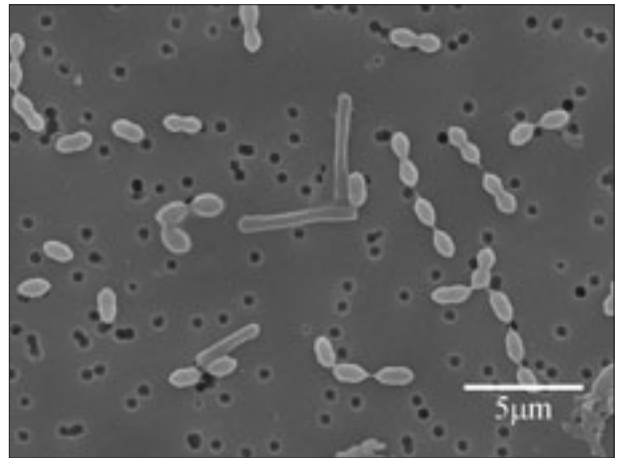

Fig. 48 LVSEM image taken by simple freeze drying.

Specimen: Lactobacillus.

In order to observe a water-containing specimen while its native state is preserved, a cryo stage is used where the specimen is frozen by liquid nitrogen and is subjected to observation on a cooling stage. Since the pressure in the specimen chamber can be kept high in an LVSEM, ice does not sublime even at a relatively high temperature. For example, if the pressure in the specimen chamber is about 100 Pa, the ice can be observed even at a cooling temperature of about -20°C . This temperature can be obtained by a Peltier element, eliminating a need for the cooling stage with liquid nitrogen. In addition, in an LVSEM, a frozen specimen can be easily imaged. That is, the specimen frozen by liquid nitrogen in the air is loaded into the specimen chamber and imaged during the rise of a temperature. Figure 48 shows an LVSEM image taken by this method (simple freeze drying).

Basics of Elemental Analysis

Generation of X-rays

As explained before, when the incident electrons enter a substance, various electrons and electromagnetic waves are emitted from the substance. Figure 49 shows the schematic diagram of the generation of characteristic X-rays. When electrons in the inner shells are emitted from the constituent atoms in the substance due to the irradiation of the incident electrons, the vacant orbits are filled with outer-shell electrons, and the substance emits X-rays whose energies correspond to the energy difference between the outer-shell electrons and the inner-shell electrons. These X-rays are called “characteristic X-rays” because their energies (wavelengths) are characteristic of individual elements. Thus, the characteristic X-rays are used for elemental analysis. Characteristic X-rays that are emitted by the excitation of the electrons in K shells are called “K lines,” whereas those emitted by the L and M shell excitations are called “L lines” and “M lines,” respectively. As the constituent element is heavier, the energy of characteristic X-rays is higher; therefore, in order to excite characteristic X-rays from heavy elements, high-energy incident electrons are required. On the other hand, when the incident electrons are decelerated by the atomic nucleus, different X-rays are emitted. These X-rays are called “continuous X-rays” or “white X-rays” or “background X-rays.”

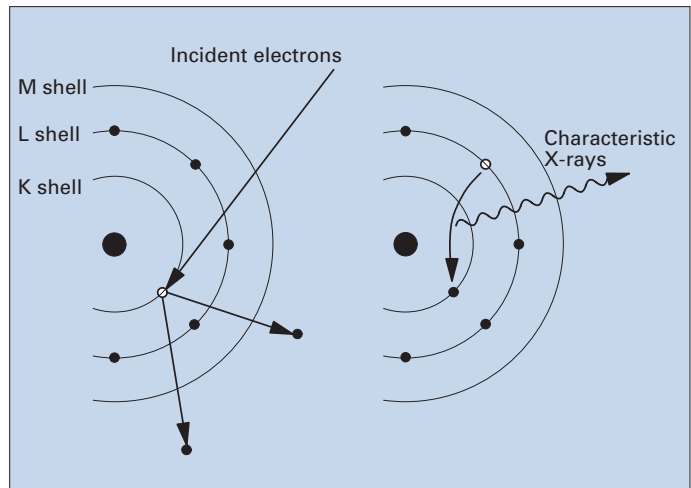

Fig. 49 Principle of the generation of characteristic X-rays.

X-ray Spectrometer

●Principle of analysis by EDS

The Energy Dispersive X-ray Spectrometer (EDS) is used to analyze characteristic X-ray spectra by measuring the energies of the X-rays. As shown in Fig. 50, when the X-rays emitted from the specimen enter the semiconductor detector, electron-hole pairs are generated whose quantities correspond to the X-ray energy. Measuring these quantities (electric current) enables you to obtain the values of X-ray energy. The detector is cooled by liquid nitrogen, in order to reduce the electric noise. The advantage of the EDS is that the X-rays from a wide range of elements from B to U are analyzed simultaneously. Figure 51 shows an example of an X-ray spectrum obtained by the EDS. The horizontal axis corresponds to the X-ray energy, whereas the vertical axis corresponds to the X-ray counts.

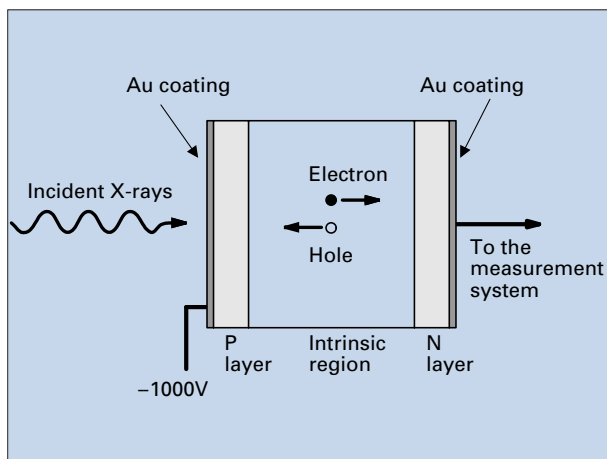

Fig. 50 Construction of the EDS semiconductor detector.

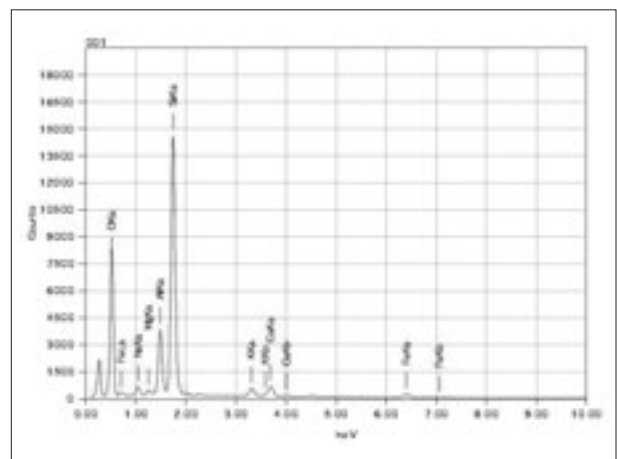

Fig. 51 Example of an EDS spectrum.

●Principle of analysis by WDS

The Wavelength Dispersive X-ray Spectrometer (WDS) is used to analyze characteristic X-ray spectra by measuring the wavelengths of the X-rays. As shown in Fig. 52, first, the X-rays emitted from the specimen hit the analyzing crystal, next, this crystal diffracts the X-rays, and finally the X-rays enter the detector and their wavelengths are measured. The analyzing crystal and detector must move on a so-called "Rowland circle" with a constant radius. In order to cover (measure) all of wavelengths, a driving mechanism for multiple analyzing crystals is needed, requiring a lot of time to acquire all of the corresponding X-ray spectra.

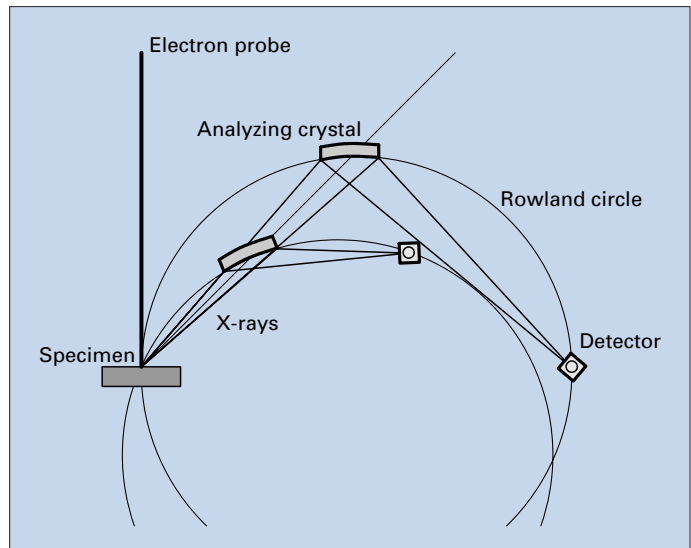

Fig. 52 Principle of WDS analysis.

●Difference between EDS and WDS

Table 2 shows differences in EDS and WDS. The EDS features measurement with a small probe current, short-time acquisition of spectra, etc. WDS features a high energy (wavelength) resolution, detection of trace elements. Most SEMs are equipped with an EDS, whereas a WDS is generally used as an Electron Probe Microanalyzer (EPMA) that mainly performs elemental analysis.

Table 2 Features of EDS and WDS

	EDS	WDS
Measurable element range	B ~ U	B ~ U
Measurement method	Energy dispersive method with a Si (Li) semiconductor detector	Wavelength dispersive method with an analyzing crystal
Resolution	$E \doteq 130 \sim 140\text{eV}$	$E \doteq 20\text{eV}$ (energy conversion)
Measuring speed	Fast	Slow
Multi-element simultaneous measurement	Possible	Impossible
Damage/contamination of specimen	Little	Many
Detection limit	1500 ~ 2000ppm	10 ~ 100ppm
Detectable X-rays per current	Many	Little

Qualitative Analysis

X-ray spectra enable us to perform qualitative analysis that identifies what elements are present in a specimen area irradiated with an electron beam. Three analysis modes are available: Point analysis to obtain a spectrum from a point irradiated with an electron beam, Line analysis to display one-dimensional distributions of elements of interest on a specified line, and Mapping to display two-dimensional distributions of elements of interest in a specified area. Mapping is often called “area analysis.” If the point analysis is applied to a certain area (not a point), this qualitative analysis is performed while the electron probe is scanned over this area (an image is observed). The detection limit is different depending on the element. For EDS, this limit is a few thousand ppm, as shown in Table 2 (page 28).

X-ray Mapping

As explained before, X-ray mapping is used to obtain the distributions of specific elements. In this analysis, the electron probe is scanned over a specified area and characteristic X-rays with specific energies are acquired. It should be noted that if the P-B ratio is extremely low (the peak intensity is very small compared to the background), X-ray maps show the distribution of continuous X-rays (not the distributions of elements of interest). In addition, you should note that if the energies of characteristic X-rays from elements not of interest are very close to those of the elements of interest, X-ray maps might show the distributions of the elements that are not of interest. This arises when the energy difference between the elements not of interest and elements of interest is equal to the energy resolution of the spectrometer. Figure 53 shows an example of X-ray mapping. Since the intensities of characteristic X-rays are smaller than those of secondary and backscattered electrons, it requires a lot of time to obtain one X-ray image.

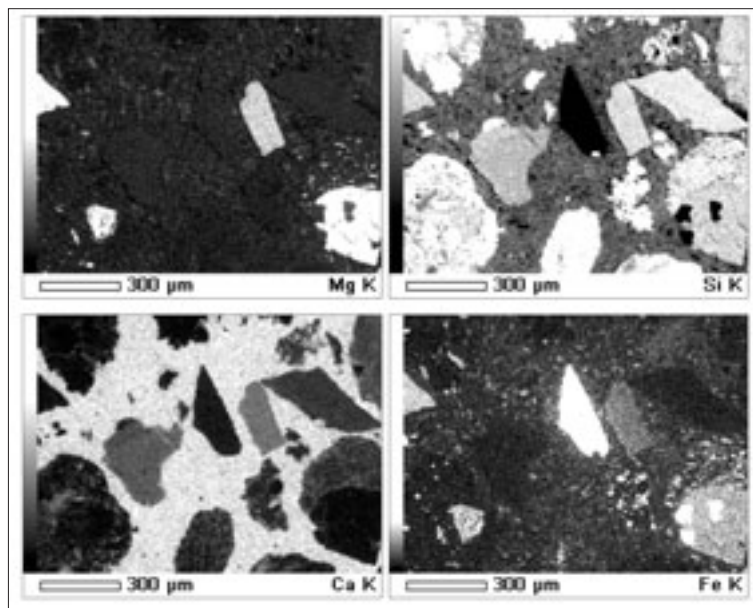

Fig. 53 Example of X-ray mapping

Specimen: Concrete piece

The resolution of X-ray mapping is limited by “analysis area” explained on the next page. But even when a particle smaller than the analysis area is present on the specimen surface, sometimes this particle can be recognized. This can happen when the particle (element) is localized in a specific area.

On the other hand, a method that quantitatively analyzes points on the specimen one by one while scanning the electron probe is called “quantitative mapping.” Using this method, even if the P-B ratio is low, accurate distribution of elements can be obtained.

This is an advantage of quantitative mapping, which cannot be achieved using simple X-ray mapping (qualitative mapping).

Analysis Area

Incident electrons that entered the specimen diffuse while losing their energy. In this process, they excite characteristic X-rays. The X-ray generation area has a certain size, and this is of the order of μm in normal operation conditions. It should be noted that even if you try to analyze a particle of a few to a few ten nm in a SEM image, an actual analysis area becomes very wide. Decreasing the accelerating voltage decreases the analysis area. However, since the accelerating voltage (electron energy) must be higher than that of the characteristic X-rays to be excited, there is a limit in decreasing the accelerating voltage. Preparation of a thin-film specimen enables you to further decrease the analysis area. For example, when a thin film with a thickness of 100 nm is analyzed at 30 kV, an analysis area of 100 nm or less can be obtained for many elements.

Quantitative Analysis

Since the intensity of characteristic X-rays is proportional to the concentration of the corresponding element, quantitative analysis can be performed. In actual experiment, a standard specimen containing elements with known concentrations is used. The concentration of a certain element in an unknown specimen can be obtained by comparing the X-ray intensities of the certain element between the standard specimen and unknown specimen. However, X-rays generated in the specimen may be absorbed in this specimen or excite the X-rays from other elements before they are emitted in vacuum. Thus, quantitative correction is needed. In the present EDS and WDS, correction calculation is easily made; however, a prerequisite is required for this correction. That is, elemental distribution in an X-ray generation area is uniform, the specimen surface is flat, and the electron probe enters perpendicular to the specimen. Actually, many specimens observed with the SEM do not satisfy this prerequisite; therefore, it should be noted that a quantitative analysis result might have appreciable errors.

Analysis of Non-conductive Specimen

When analyzing a nonconductive specimen, metal coating is required as in SEM observation. However, you must use a metal that is different from that may be contained in a specimen. When you want to detect light elements, a coated film must be thin enough because a thick heavy-metal coated film may prevent the emission of X-rays from light elements.

If you try to analyze a nonconductive specimen without coating, this specimen is analyzed with a low accelerating voltage caused by the charging effect. Thus, some problems may occur; for example, characteristic X-rays with high excitation energies cannot be detected, and the accuracy of quantitative analysis is degraded. In addition, positional shift of the incident electron probe may occur when line analysis or X-ray mapping is performed.

The use of the LVSEM enables you to analyze a nonconductive specimen without coating. However, in the specimen chamber in the LVSEM, the incident electron probe is broadly scattered by residual gas molecules existing in the electron-beam path, increasing the analysis area. You should note this problem.

History

The development of a SEM began a few years after the invention of a TEM by Ruska in 1931. But the commercialization of the SEM required about 30 years. Figure 54 shows the history of the initial development stage of the SEM.

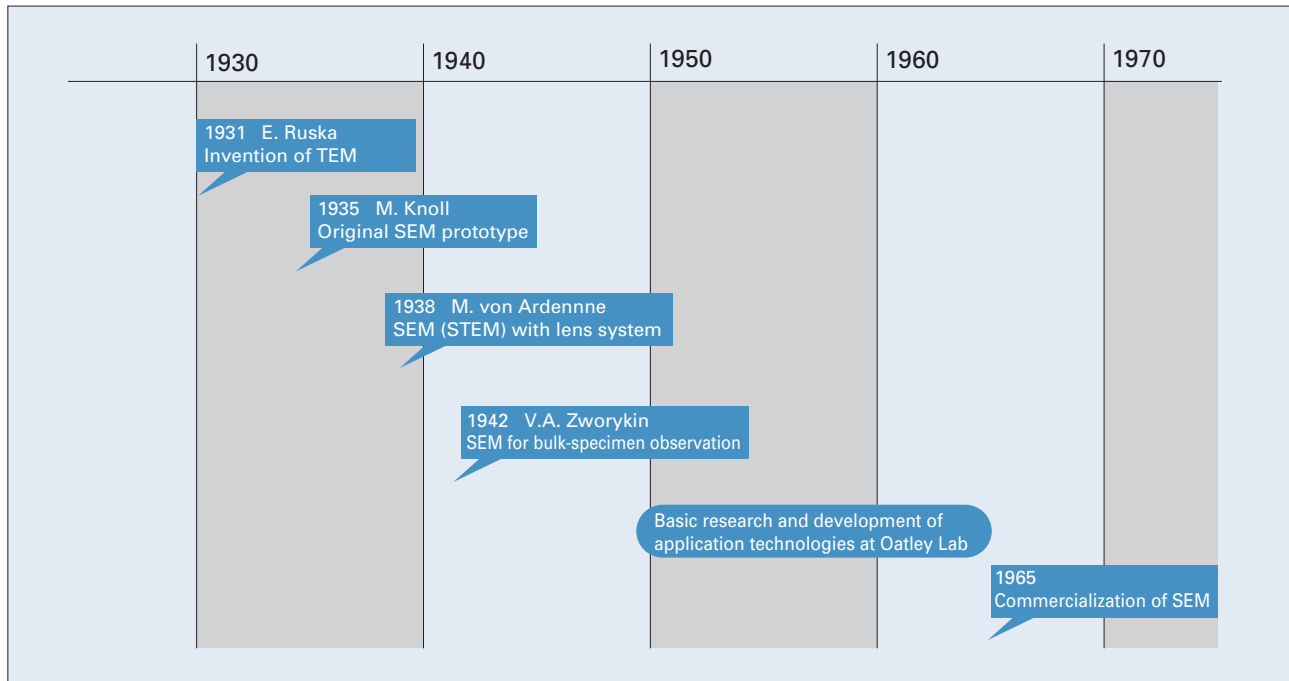

Fig. 54 History of the initial development stage of the SEM.

In 1935, the original prototype of the SEM, which scans the specimen with an electron beam to obtain an image, was made by Knoll (Germany). Knoll was also involved in the development of the first TEM, and he developed this prototype SEM to study the material for a TV camera tube. He housed an electron gun and a specimen in a vacuum-sealed glass tube. Then, the specimen was irradiated with an 100 μm -diameter electron beam and an absorbed current image was taken from the specimen.

A SEM that incorporates a demagnifying lens system was first developed by von Ardenne (Germany) in 1938. The height of the optical column of this instrument was about 2 m, and a small electron probe with a diameter of 4 nm was produced by a demagnifying lens system comprised of a two-stage electrostatic lens. This instrument was dedicated to Scanning Transmission Electron Microscopy (STEM) and it was used for thin-film specimens. An image obtained with this SEM was recorded directly on a photographic film placed below the specimen. The image was not visible until developing the photographic film because a CRT was not equipped with this instrument. He did not observe bulk specimens, but he published an article on his idea for a secondary electron detector that utilizes an electronic amplifier.

In 1942, Zworykin, RCA Corporation (USA), developed a SEM for observing bulk specimens. This instrument combined an FE gun and a four-stage demagnifying lens system, and a scintillator was used for detecting secondary electrons. For image recording, a facsimile was used. Secondary electron images obtained with this instrument were inferior to those obtained by the replica method in the TEM, thus, RCA stopped the development of the SEM. Furthermore, the interest of many researchers shifted to the development of TVs and the research on the SEM suspended for about 10 years. The restart of developing a SEM was launched at the Oatley Laboratory in Cambridge University (UK), around the early 1950s.

In his laboratory, much basic research on the SEM was performed. In 1953, McMullan succeeded in the development of a SEM producing a resolution of 50 nm at accelerating voltages from 15 to 20 kV, and his laboratory made five SEMs of this kind until 1965. During this period, many developments were made and they became the basis of the present SEMs. The achievements included the E-T detector which has been a prototype of the secondary electron detector of present SEMs, various observation techniques, and application technologies. Also in 1961, an SEM made in the Oatley Laboratory was installed in a pulp company in Canada.

In 1965, Cambridge Scientific Instrument (UK) and JEOL (Japan) first commercialized a SEM, individually. During the four decades after the first commercialization of the SEM, about several tens of thousands of SEMs have been manufactured. Now, the SEM has made significant advances in its performance and functions, and it continues to develop into a more sophisticated instrument.



Certain products in this brochure are controlled under the "Foreign Exchange and Foreign Trade Law" of Japan in compliance with international security export control. JEOL Ltd. must provide the Japanese Government with "End-user's Statement of Assurance" and "End-use Certificate" in order to obtain the export license needed for export from Japan. If the product to be exported is in this category, the end user will be asked to fill in these certificate forms.

JEOL JEOL Ltd. 1-2 Musashino 3-chome Akishima Tokyo 196-8558 Japan Sales Division ☎(042)528-3381 傳(042)528-3386 <http://www.jeol.com/>

ARGENTINA
COASIN S.A.C.I.yF.
Virrey del Pino 4071,
1430 Buenos Aires
Argentina
Telephone: 54-11-4552-3185
Facsimile: 54-11-4555-3321

AUSTRALIA & NEW ZEALAND
JEOL(AUSTRALASIA) Pty.Ltd.
Suite 1, L2 18 Aquatic Drive
- Frenchs Forest NSW 2086
Australia
Telephone: 61-2-9451-3855
Facsimile: 61-2-9451-3822

AUSTRIA
LABCO GmbH
Dr.-Trittemmel-Gasse 8,
A-3013 Pressbaum, Austria
Telephone: 43-2233-53838
Facsimile: 43-2233-53176

BANGLADESH
A.Q. CHOWDHURY SCIENCE & SYNERGY PVT. LTD.
House No. 12, Road No. 5A
Sector No. 11, Uttara Dhaka - 1230
Bangladesh
Telephone: 880-2-9980790, 8953450, 8953501
Facsimile: 880-2-8854428

BELGIUM
JEOL (EUROPE) B.V.
Planet II, Building B
Leuvensesteenweg 542,
B-1930 Zaventem
Belgium
Telephone: 32-2-720-0560
Facsimile: 32-2-720-6134

BRAZIL
FUGIWARA ENTERPRISES
INSTRUMENTOS CIENTIFICOS LTDA.
Avenida Itaberaba, 3563
02739-000 Sao Paulo, SPI Brazil
Telephone: 55-11-3983 8144
Facsimile: 55-11-3983 8140

CANADA
JEOL CANADA, INC.
(Represented by Soquelec, Ltd.)
5757 Cavendish Boulevard, Suite 540,
Montreal, Quebec H4W 2W8, Canada
Telephone: 1-514-482-6427
Facsimile: 1-514-482-1929

CHILE
TECSIS LTDA.
Avenida Kennedy 5454 - Piso 5
Vitacura, Santiago, Chile
Telephone: 56-2-401-8520
Facsimile: 56-2-410-8541

CHINA
JEOL LTD., BEIJING OFFICE
Room B1110/11, Wantong New World Plaza
No. 2 Fuchengmenwai Street, Xicheng District,
Beijing 100037, P.R.China
Telephone: 86-10-6804-6321/6322/6323
Facsimile: 86-10-6804-6324

JEOL LTD., SHANGHAI OFFICE
Shanghai Equatorial Hotel Office Building 803,
65 Yanan Road West, Shanghai 200040, P.R. China
Telephone: 86-21-6248-4075
Facsimile: 86-21-6248-4075

JEOL LTD., GUANG ZHOU OFFICE
N3104, World Trade Center Building
371-375, Huan Shi East-Road, Guang Zhou,
510095, P.R.China
Telephone: 86-20-8778-7848
Facsimile: 86-20-8778-4268

JEOL LTD., WUHAN OFFICE
Room 3216, World Trading Bldg,
686 Jiefang Street, Hankou, Wuhan, Hubei 430032
P.R.China
Telephone: 86-27-8544-8953
Facsimile: 86-27-8544-8695

JEOL LTD., CHENGDU OFFICE
1807A Zongfu Building,
NO. 45 Zhongfu Road, Chengdu, Sichuan, 610016
P.R. China
Telephone: 86-28-86622554
Facsimile: 86-28-86622564

EGYPT
JEOL SERVICE BUREAU
3rd Fl. Nile Center Bldg., Nawal Street,
Dokki, (Cairo), Egypt
Telephone: 20-2-335-7220
Facsimile: 20-2-338-4186

FRANCE
JEOL (EUROPE) SAS
Espace Claude Monet, 1 Allee de Giverny
78290, Croissy-sur-Seine, France
Telephone: 33-13015-3737
Facsimile: 33-13015-3747

GERMANY
JEOL (GERMANY) GmbH
Oskar-Von-Miller-Strasse 1A, 85386
Eching, Germany
Telephone: 49-8165-77346
Facsimile: 49-8165-77512

GREAT BRITAIN & IRELAND
JEOL (U.K.) LTD.
JEOL House, Silver Court, Watchmead,
Wetwyn Garden City, Herts AL7 1LT, U.K.
Telephone: 44-1707-377117
Facsimile: 44-1707-373254

GREECE
N. ASTERIADIS S.A.
56-58 S. Trikoupi Str. P.O. Box 26140
GR-10022, Athens, Greece
Telephone: 30-1-823-5383
Facsimile: 30-1-823-9567

HONG KONG
FARMING LTD.
Unit 1009, 10/F., MLC Millennia Plaza
663 King's Road, North Point, Hong Kong
Telephone: 852-2815-7299
Facsimile: 852-2581-4635

INDIA
BLUE STAR LTD. (HQ: Mumbai)
Analytical Instruments Department,
Sahas' 414/2 Veer Savarkar Marg
Prabhadery Mumbai 400 025, India
Telephone: 91-22-6666-4000
Facsimile: 91-22-6666-4001

BLUE STAR LTD. (Delhi)
Analytical Instruments Department,
E-44/12 Okhla Industrial Area,
Phase-II, New Delhi 110 020, India
Telephone: 91-11-4149-4000
Facsimile: 91-11-4149-4005

BLUE STAR LTD. (Calcutta)
Analytical Instruments Department,
7, Hare Street Calcutta 700 001, India
Telephone: 91-33-2213-4133
Facsimile: 91-33-2213-4102

BLUE STAR LTD. (Chennai)
Analytical Instruments Department,
Garuda Building,
46, Cathedral Road, Chennai 600 086, India
Telephone: 91-44-4244-4000
Facsimile: 91-44-4244-4190

INDONESIA
PT. TEKNO LABINDO Penta Perkasa
Komplek Gading Bukit Indah Blok I/11
Jl. Bukit Gading Raya Kelapa Gading Permai,
Jakarta 14240, Indonesia
Telephone: 62-21-45847057/58/59
Facsimile: 62-21-45842729

ITALY
JEOL (ITALIA) S.p.A.
Centro Direzionale Green Office
Via dei Tulipani, 1
20090 Pieve Emanuele (MI) Italy
Telephone: 39-02-90414343
Facsimile: 39-02-90414343

KOREA
JEOL KOREA LTD.
Dongwoo Bldg. 7F, 458-5, Gil-Dong,
Gangdong-Gu, Seoul, 134-010, Korea
Telephone: 82-2-511-5501
Facsimile: 82-2-511-2635

KUWAIT
YUSUF I.AL-GHANIM&CO.(YIACO)
P.O. Box 435
13005-Safat, Kuwait
Telephone: 965-4832600/4814358
Facsimile: 965-4844954/4833612

MALAYSIA
JEOL(MALAYSIA) SDN.BHD.(359011-M)
205, Block A, Mezzanine Floor,
Kelana Business Center,
97, Jalan SS 7/2, Kelana Jaya,
47301 Petaling Jaya, Selangor, Malaysia
Telephone: 60-3-7492-7722
Facsimile: 60-3-7492-7723

MEXICO
JEOL DE MEXICO S.A. DE C.V.
Av. Amsterdam #46 DEPS. 402
Col Hipodromo, 06100, Mexico D.F.
Mexico
Telephone: 52-5-55-211-4511
Facsimile: 52-5-55-211-0720

PAKISTAN (Karachi)
ANALYTICAL MEASURING SYSTEM (PVT) LTD.(AMS LTD.)
14-C Main Sehar Commercial Avenue Lane 4,
Khayaban-e-Sehar,
D.H.A-VII, Karachi-75500, Pakistan
Telephone: 92-21-5345581/5340747
Facsimile: 92-21-5345582

PANAMA
PROMED S.A.
Parque Industrial Costa del Este
Urbanizacion Costa del Este
Apartado 0816-01755, Panama, Panama
Telephone: 507-303-3100
Facsimile: 507-303-3115

PHILIPPINES
PHILAB INDUSTRIES INC.
7487 Bagtikan Street, SAV Makati,
1203 Metro, Manila Philippines
Telephone: 63-2-896-7218
Facsimile: 63-2-897-7732

PORTUGAL
Izasa Portugal Lda.
R. do Proletariado, 1
2790-138 CARNAXIDE, Portugal
Telephone: 351-21-424-73-00
Facsimile: 351-21-418-60-20

RUSSIA
JEOL LTD Moscow Office
Pereulok Krasina 16, bld 1. Office 302,
Moscow, Russia
Telephone: 7-495-641-11-14
Facsimile: 7-495-641-28-63

SAUDI ARABIA
ABDULREHMAN ALGOSAIBI G.T.C (Riyadh)
King Abdulaziz Avenue,
P.O. Box 215, Riyadh 11411, Saudi Arabia
Telephone: 966-1-479-3000
Facsimile: 966-1-477-1374

SCANDINAVIA
JEOL (SKANDINAVISKA) A.B.
Hammarbacken 6A, Box 716, 191 27 Sollentuna
Sweden
Telephone: 46-8-28-2800
Facsimile: 46-8-29-1647

SERVICE & INFORMATION OFFICE
JEOL NORWAY
Ole Deviks vei 28, N-0614 Oslo, Norway
Telephone: 47-2-2-64-7930
Facsimile: 47-2-2-65-0619

JEOL FINLAND
Ylakaupinkuja 2, FIN-02360 Espoo, Finland
Telephone: 358-9-8129-0350
Facsimile: 358-9-8129-0351

JEOL DENMARK
Naverland 2, DK-2600 Glostrup, Denmark
Telephone: 45-4345-3434
Facsimile: 45-4345-3433

SINGAPORE
JEOL ASIA PTE. LTD.
2 Corporation Road #01-12 Corporation Place
Singapore 618494
Telephone: 65-6565-9989
Facsimile: 65-6565-7552

SOUTH AFRICA
ADI Scientific (Pty) Ltd.
109 Blandford Road, North Riding, Randburg
(PO box 71295 Bryanston 2021)
Republic of South Africa
Telephone: 27-11-462-1363
Facsimile: 27-11-462-1466

SPAIN
IZASA S.A.
Argoneses, 13, 28100 Alcobendas,
(Poligono Industrial), Madrid, Spain
Telephone: 34-91-663-0500
Facsimile: 34-91-663-0545

SWITZERLAND
JEOL (GERMANY) GmbH
Oskar-Von-Miller Strasse 1,
85386 Eching, Germany
Telephone: 49-8165-77346
Facsimile: 49-8165-77512

TAIWAN
JIE DONG CO., LTD.
7F, 112, Chung Hsiao East Road,
Section 1, Taipei, Taiwan 10023
Republic of China
Telephone: 886-2-2395-2978
Facsimile: 886-2-2322-4655

For Semiconductor Products:
JEOL TAIWAN SEMICONDUCTORS LTD.
11F, No. 346, Pei-Ta Road, Hsin-Chu City 300,
Taiwan, Republic of China
Telephone: 886-3-523-8490
Facsimile: 886-3-523-8503

THAILAND
BECTHAI BANGKOK EQUIPMENT & CHEMICAL CO., Ltd.
300 Phaholyothin Rd. Phayathai, Bangkok 10400,
Thailand
Telephone: 66-2-615-2929
Facsimile: 66-2-615-2350/2351

THE NETHERLANDS
JEOL (EUROPE) B.V.
Lireweg 4, NL-2153 PH Nieuw-Vennep,
The Netherlands
Telephone: 31-252-623500
Facsimile: 31-252-623501

TURKEY
TEKSER LTD.STI.
Acibadem Cad. Erdem Sok, N° 6/1
34660, Uskudar, Istanbul, Turkey
Telephone: 90-216-3274041
Facsimile: 90-216-3274046

UAE
BUSINESS COMMUNICATIONS LLC. (Abu Dhabi)
P.O. Box 2534, Abu Dhabi UAE
Telephone: 971-2-6348495
Facsimile: 971-2-6316465

BUSINESS COMMUNICATIONS LLC. (Dubai)
P.O. Box 233, Dubai, UAE
Telephone: 971-4-2220186
Facsimile: 971-4-2236193

USA
JEOL USA, INC.
11 Dearborn Road, Peabody, MA 01960, U.S.A.
Telephone: 1-978-535-5900
Facsimile: 1-978-536-2205/2206

JEOL USA, INC. WEST OFFICE
5653 Stoneridge Drive Suite #110
Pleasanton, CA 94588, U.S.A.
Telephone: 1-925-737-1740
Facsimile: 1-925-737-1749

VENEZUELA
GOMSA Service and Supply C.A.
Urbanizacion Montalban III
- Residencias Don Andres - Piso 7 - Apartamento 74
Avenida 3, entre calles 7 y 6
Montalban, Caracas, Venezuela
Telephone: 58-212-443-4342
Facsimile: 58-212-443-4342

VIETNAM
TECHNICAL MATERIALS AND RESOURCES IMPORT-
EXPORT JOINT STOCK COMPANY(REXCO)
Hanoi Branch
157 Lang Ha Road, Dong da District, Hanoi, Vietnam
Telephone: 84-4-562-0516, 17/562-0535
Facsimile: 84-4-853-2511